

## EIR2030 4 Person Outdoor Infrared Sauna Drawing Pack

**07.12.21**

To be read with:

- Outdoor Sauna Assembly manual
- Part Schedule
- Heater Manual

All dimensions in millimeters



**Oceanic Saunas Ltd**

Pountney Street  
Wolverhampton WV2 4HX  
01902 450 550  
[www.oceanic-saunas.co.uk](http://www.oceanic-saunas.co.uk)

**EIR2030 Part Document**

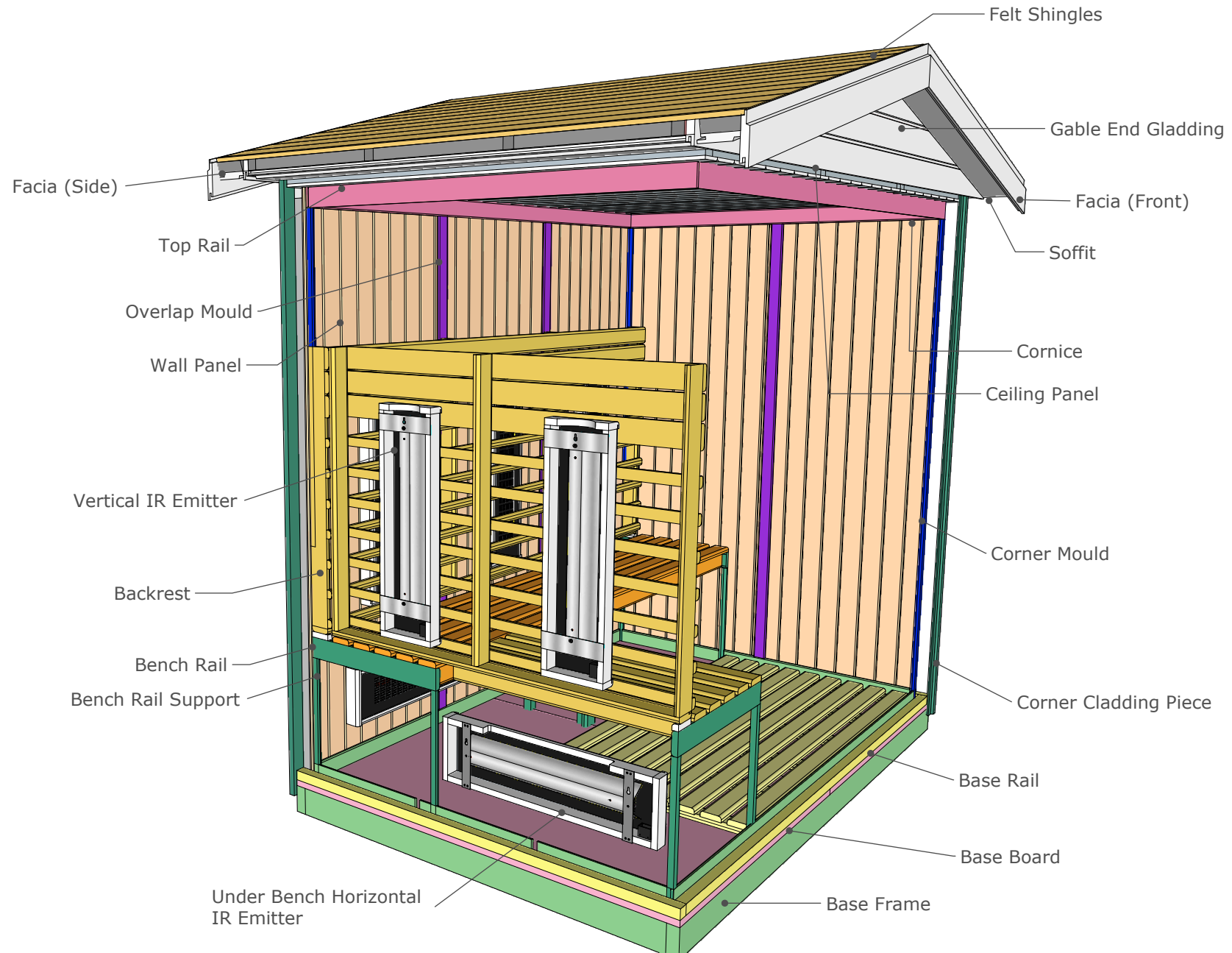

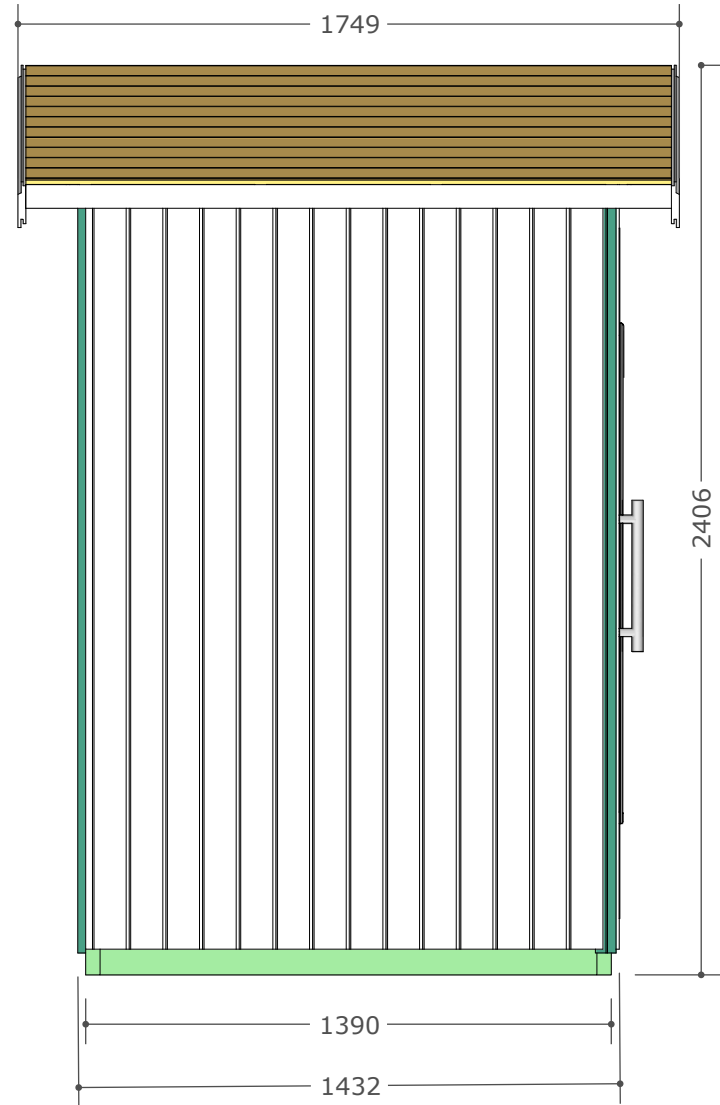
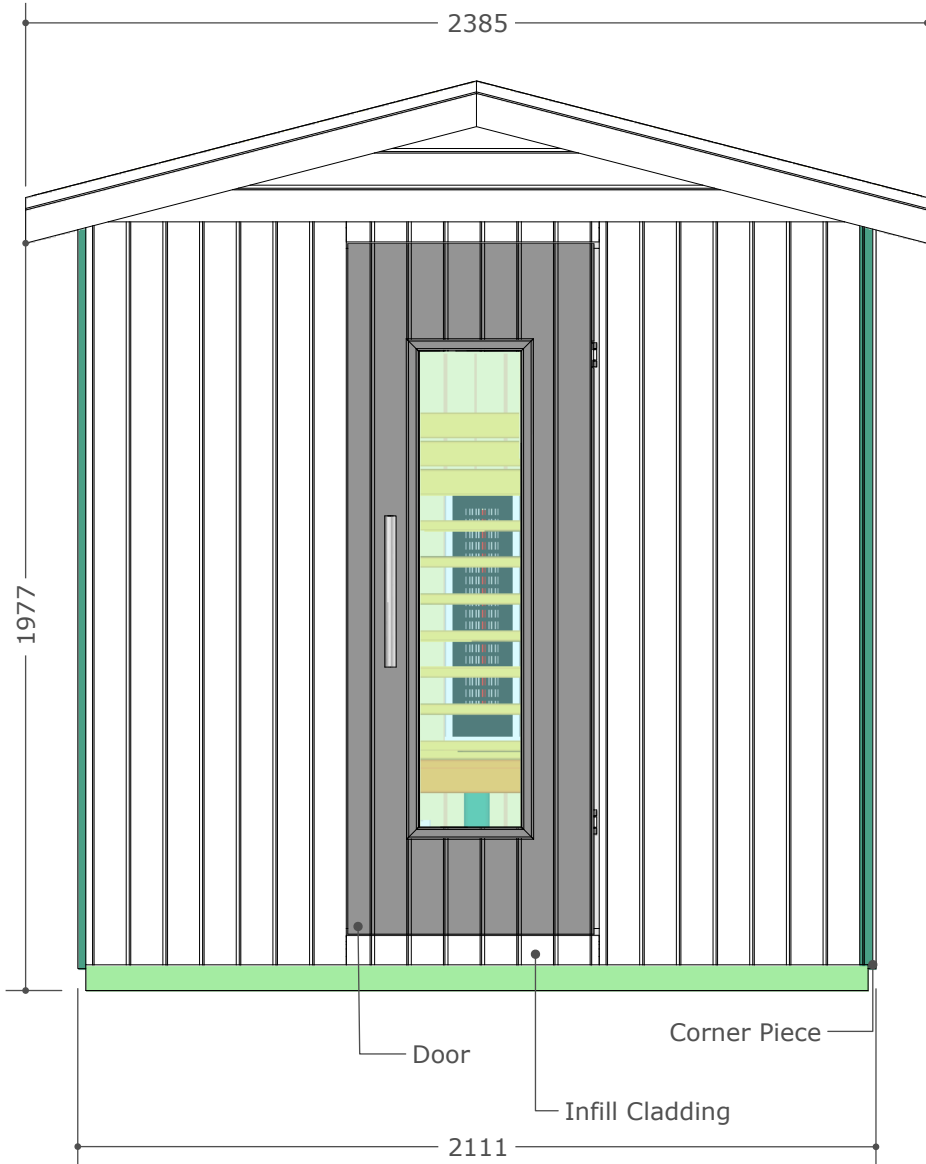

### Base Frame

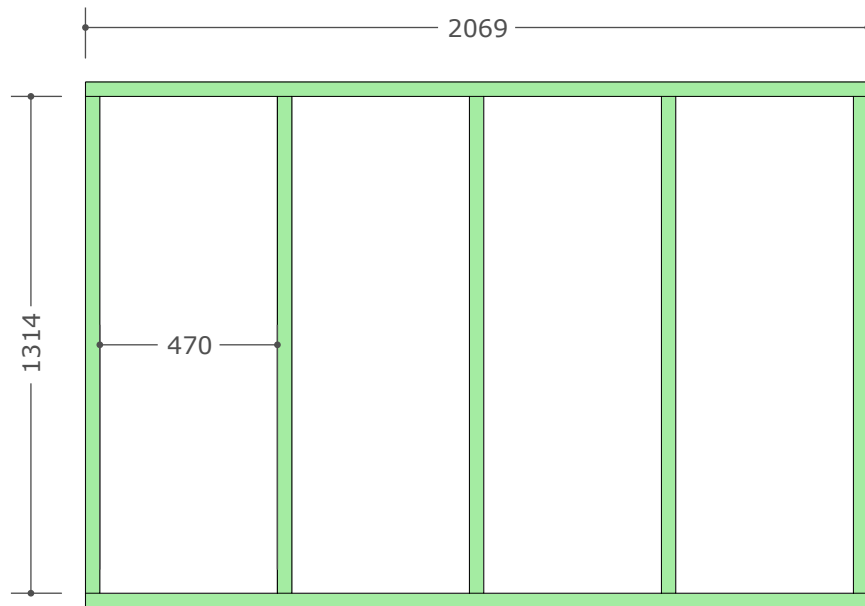

### Base Boards

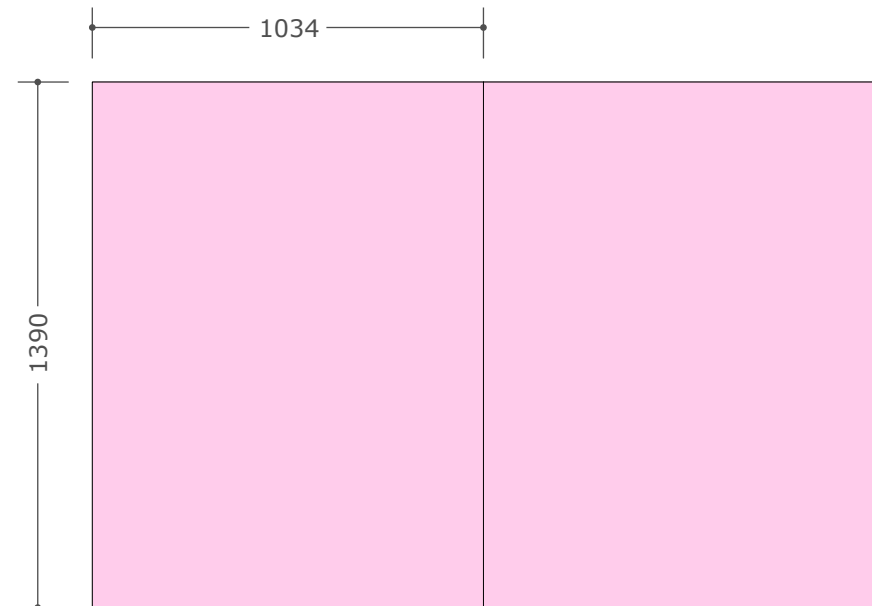

### Base Rails

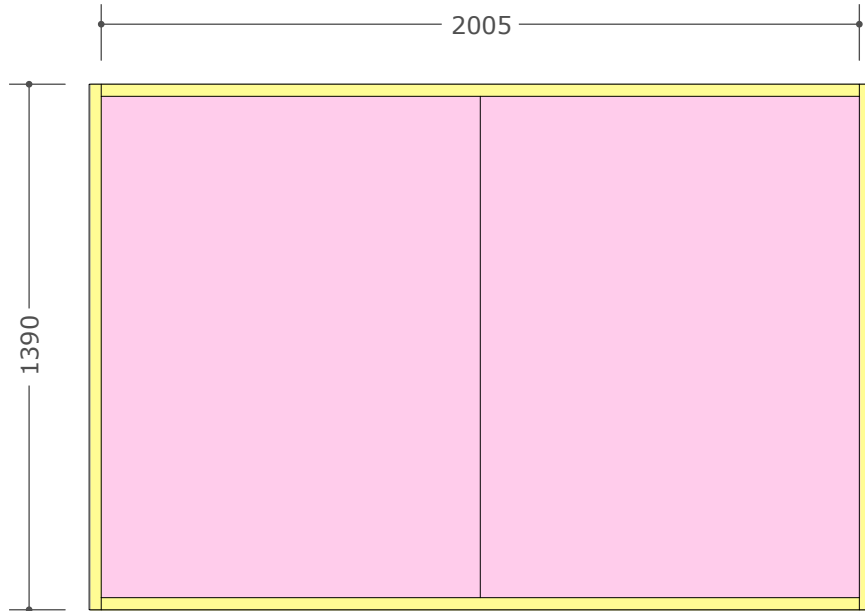

### Wall Panels

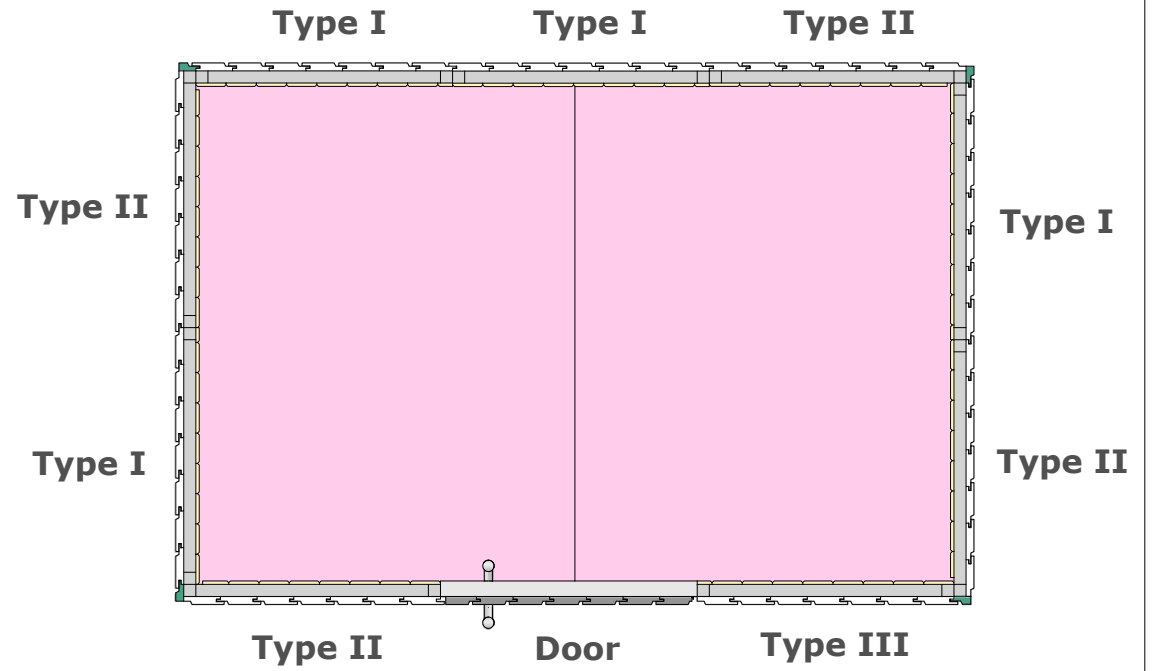

### Gable Cladding

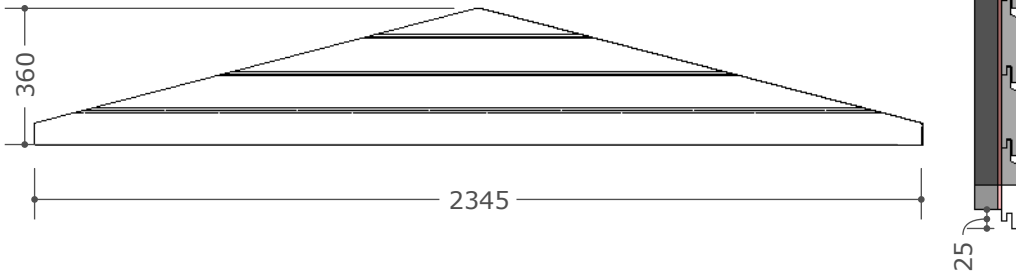

### Gable Frame

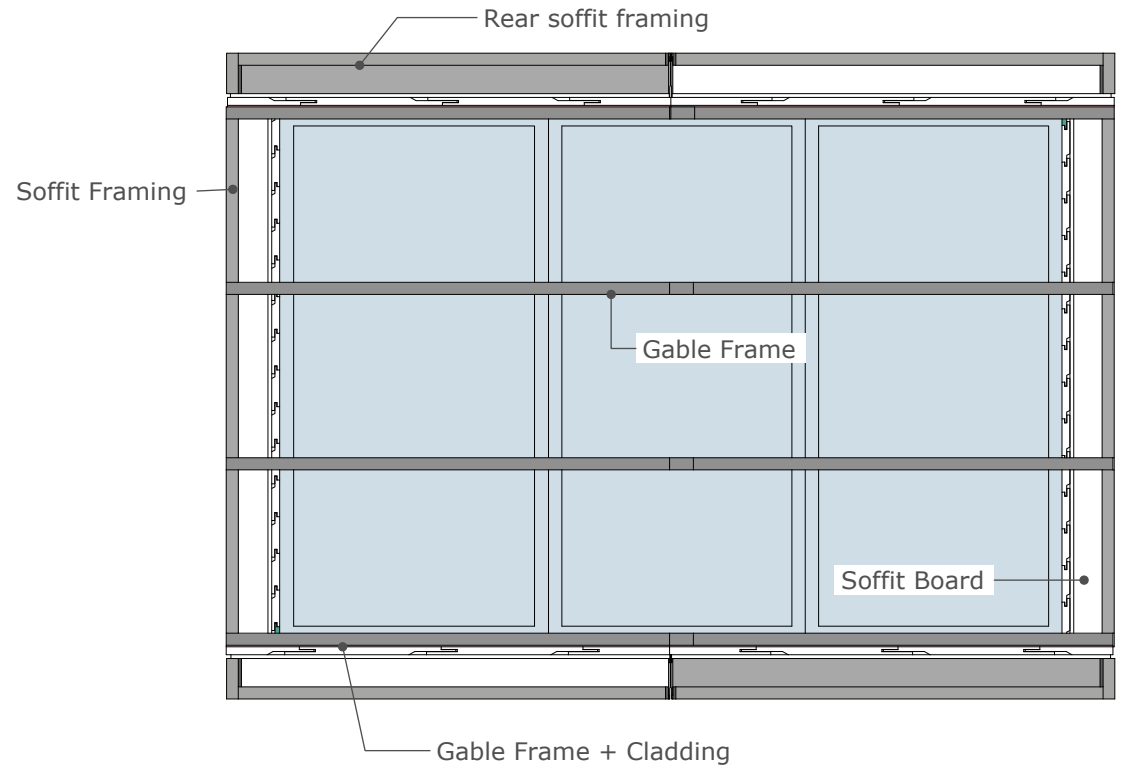
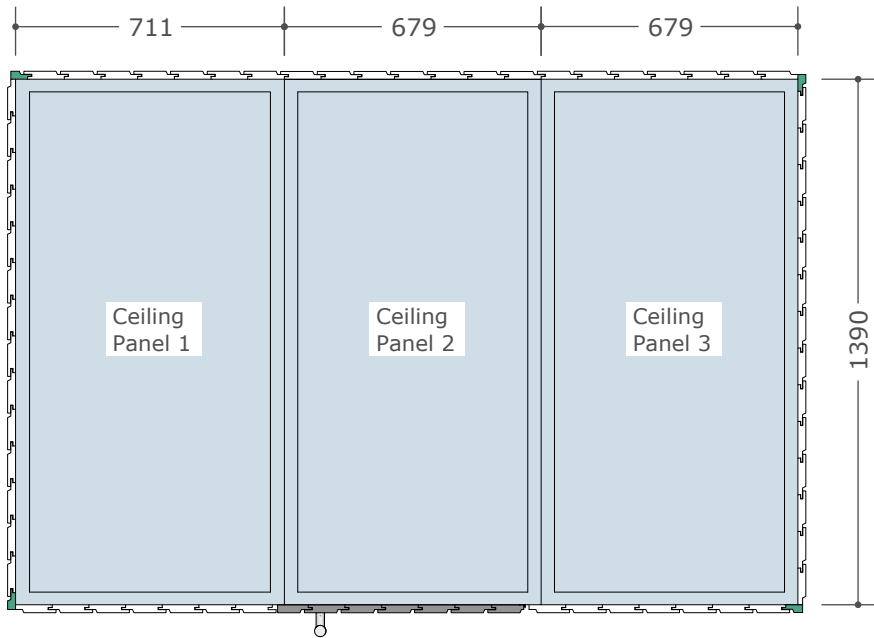
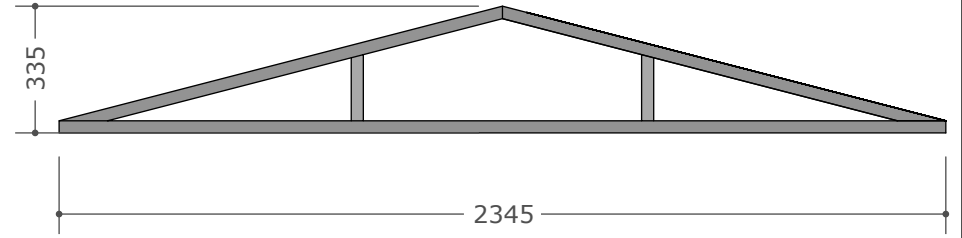

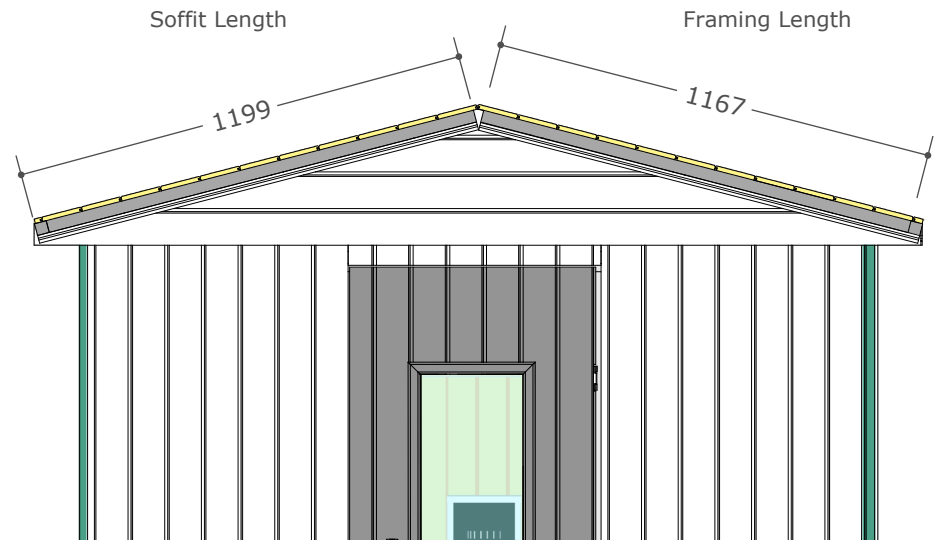
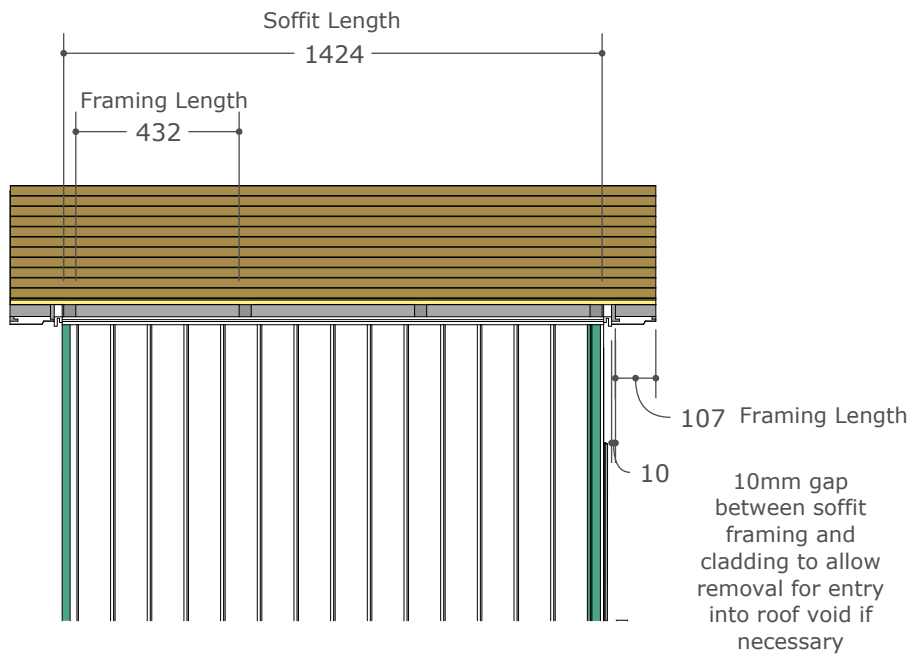
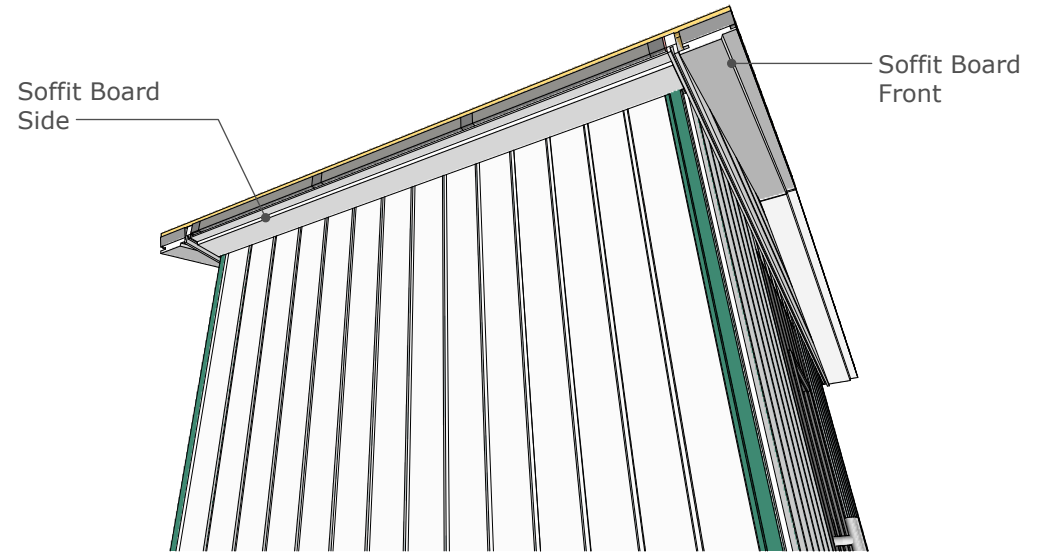
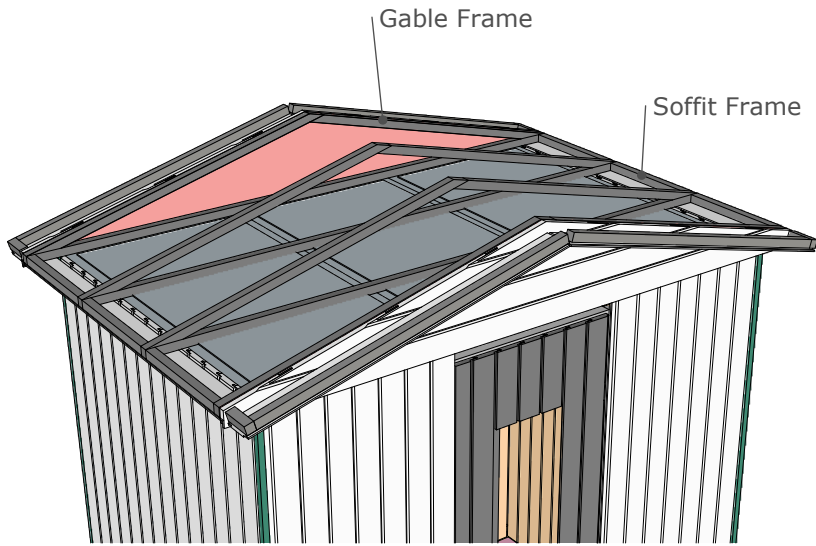

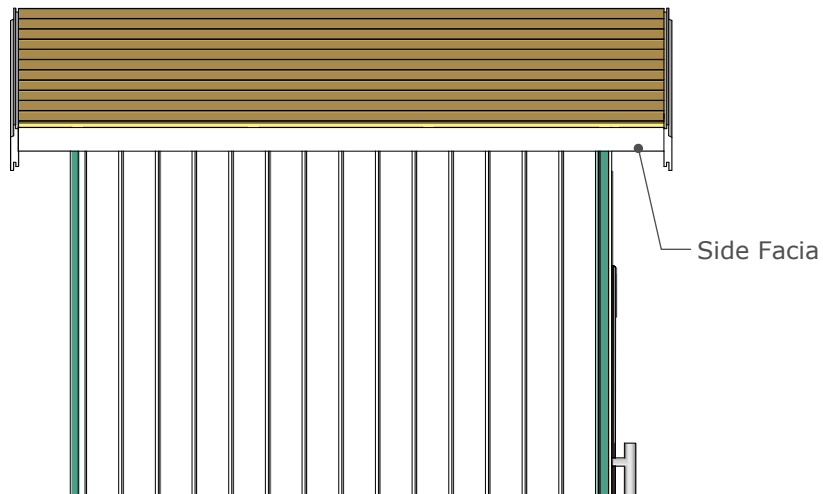
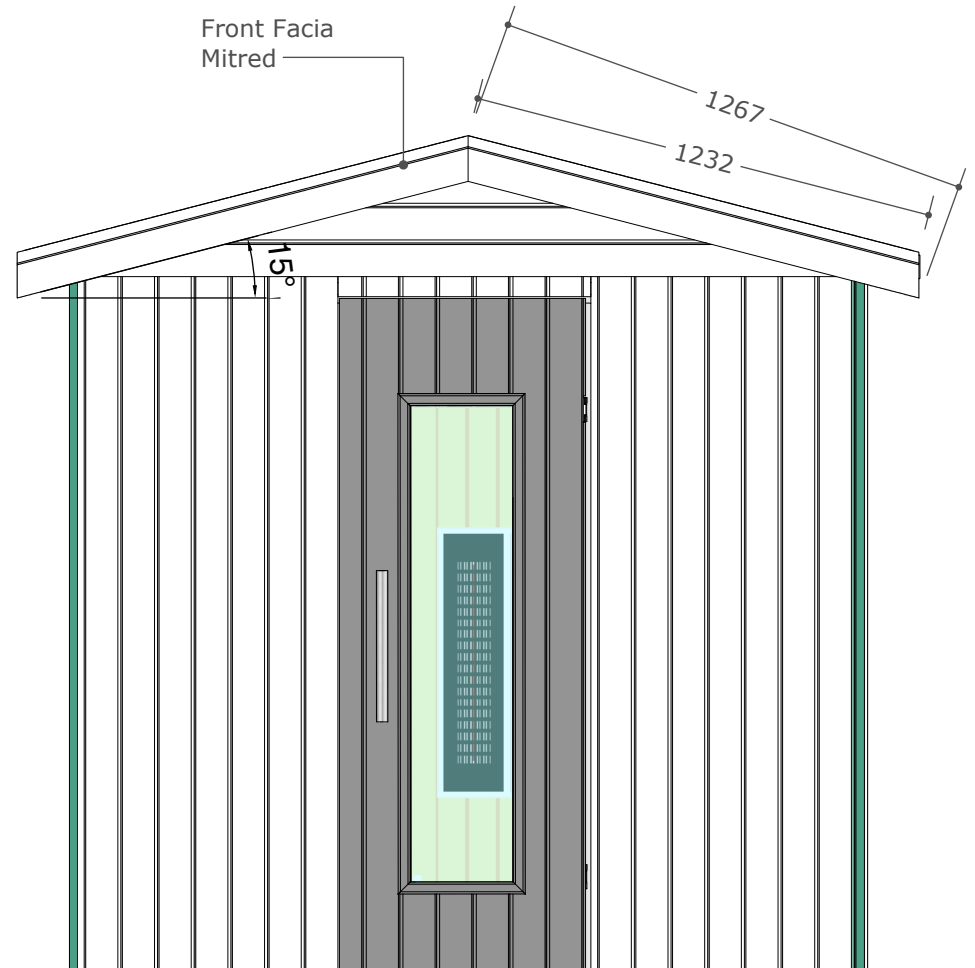
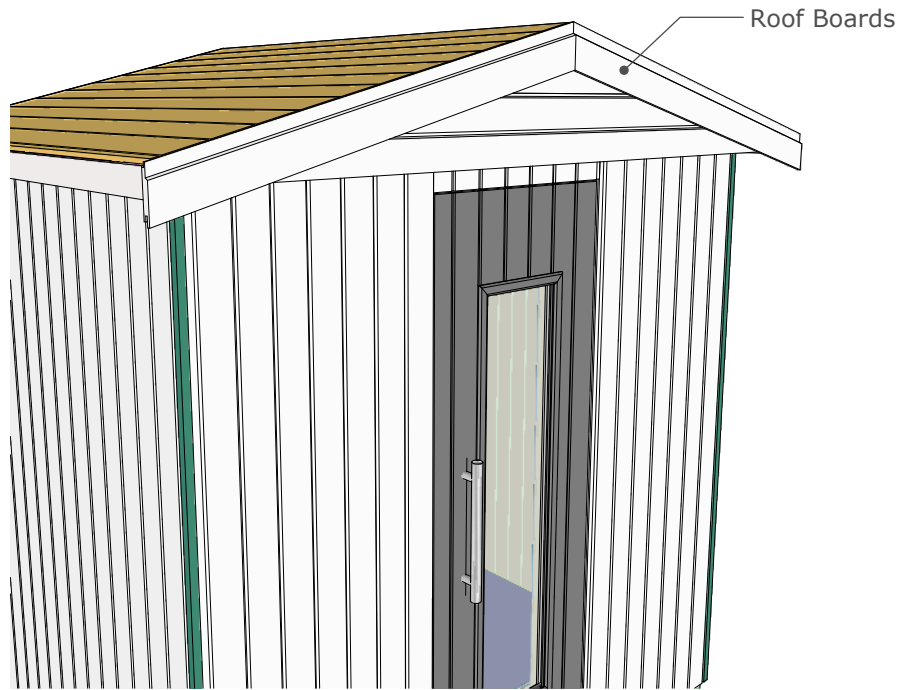



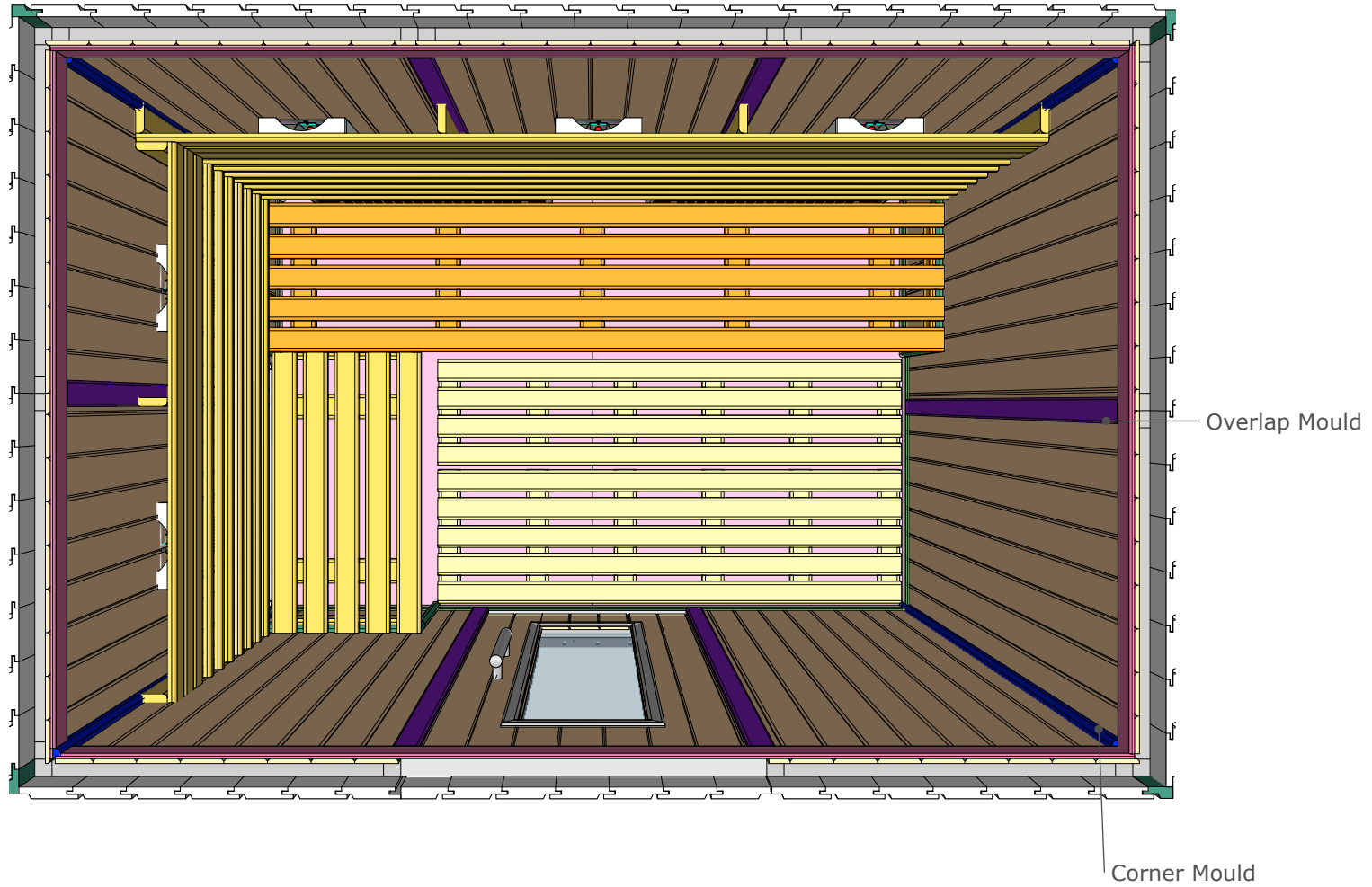

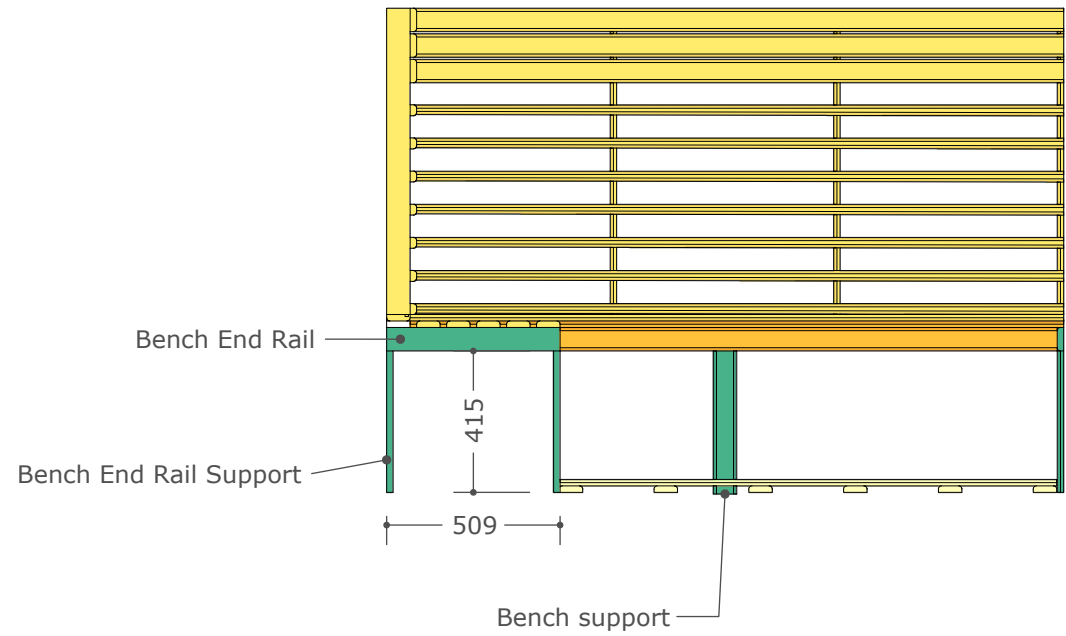
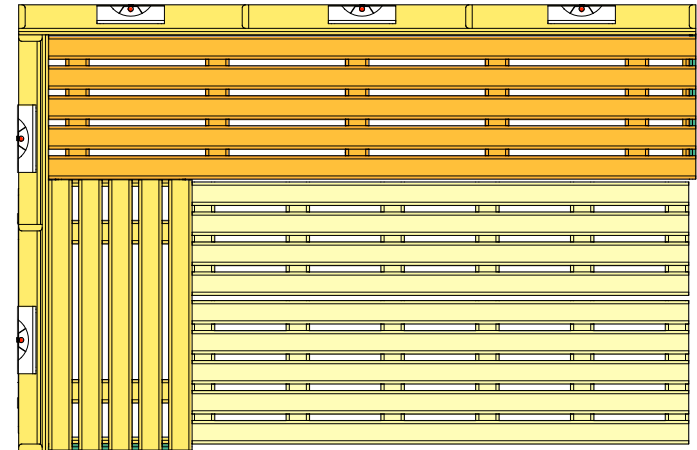
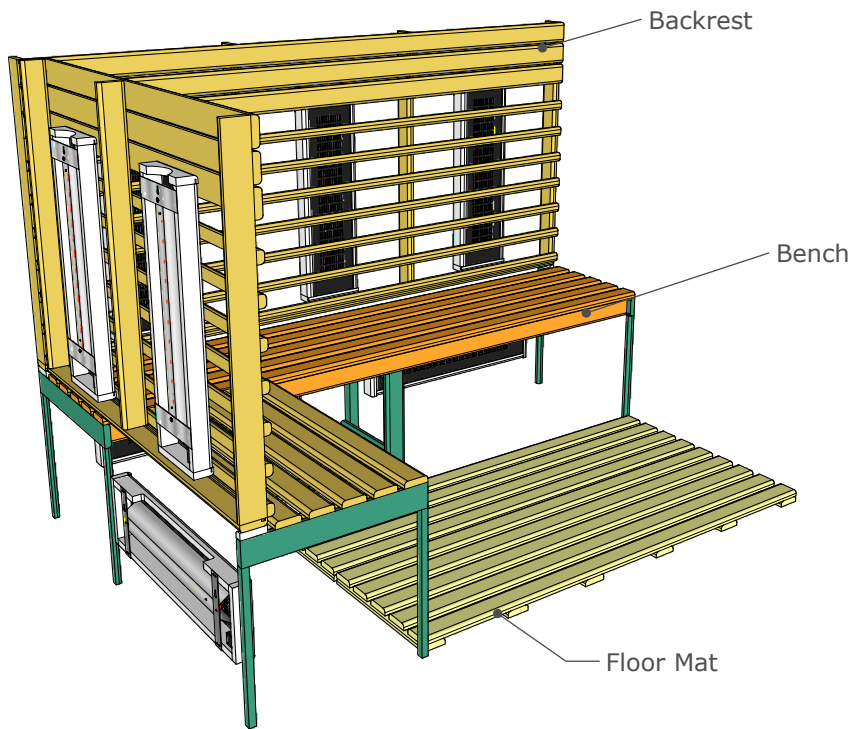

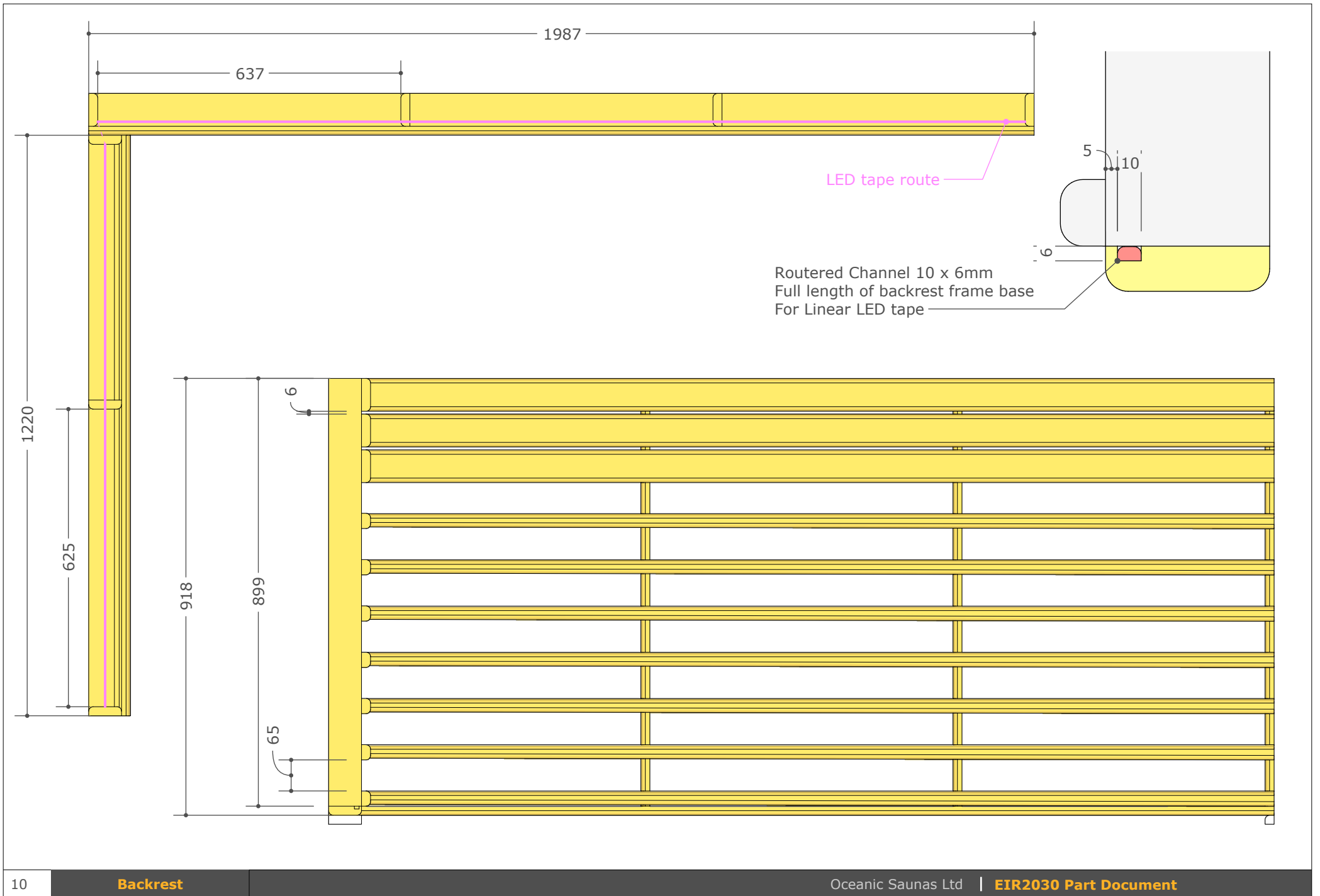

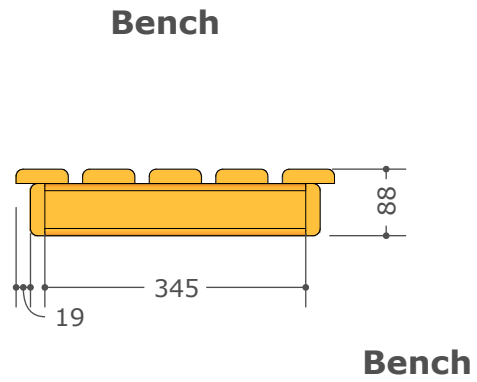

**L Bench**

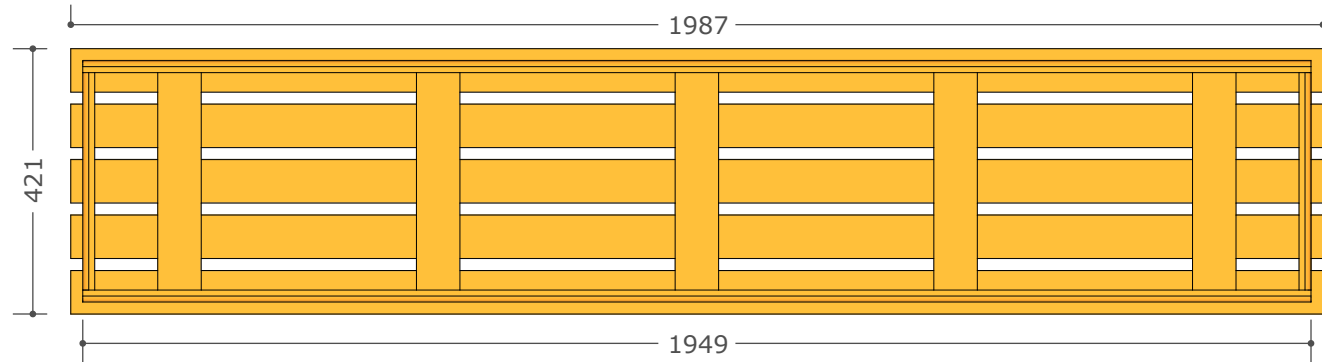
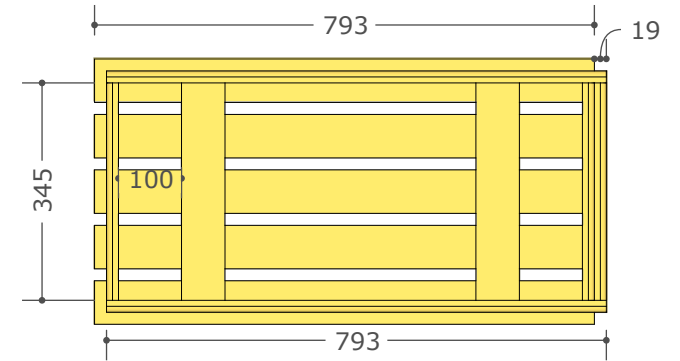

**Floor Mat**

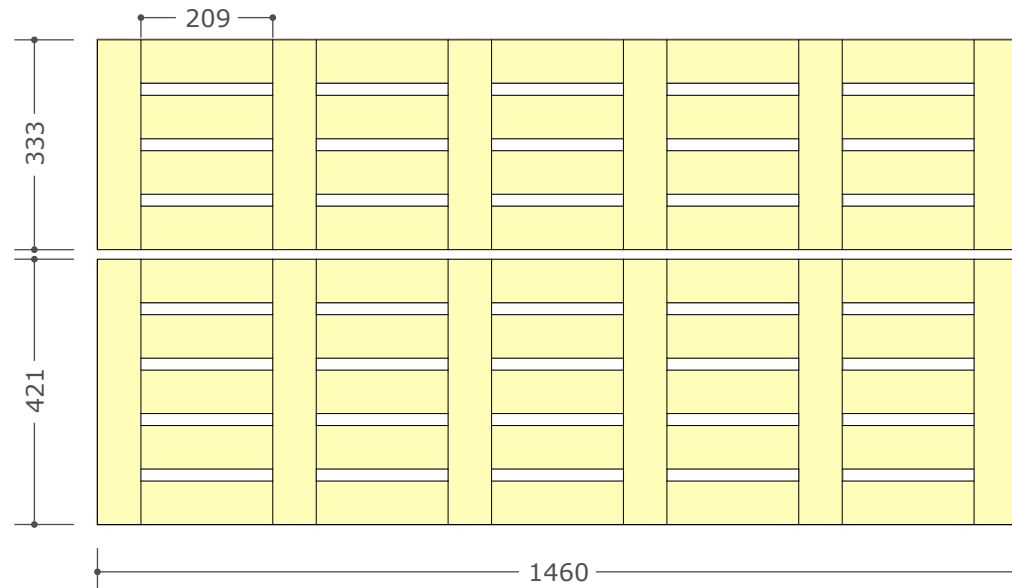

- Mains Cable Input
- Wall Heater
- - - Under Bench Heater
- Keypad
- Temperature Sensor
- Down Lights
- Linear LED backrest Light (optional)
- Speaker (optional)

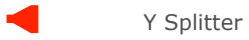

Y Splitter

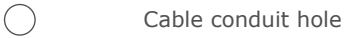

Cable conduit hole



Downlight

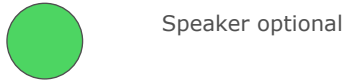

Speaker optional

