

Timber List			
Part	Section (mm)	Length (mm)	Qty
Bench	69 x 19	1230	5
	69 x 19	1192	2
	69 x 19	345	6
Bench End Rail	69 x 19	509	2
Rail Support	19 x 19	412	2
Backrest	69 x 19	1230	4
	69 x 19	899	3
	19 x 19	1230	5
Floor Mat	69 x 19	1180	7
	69 x 19	597	4

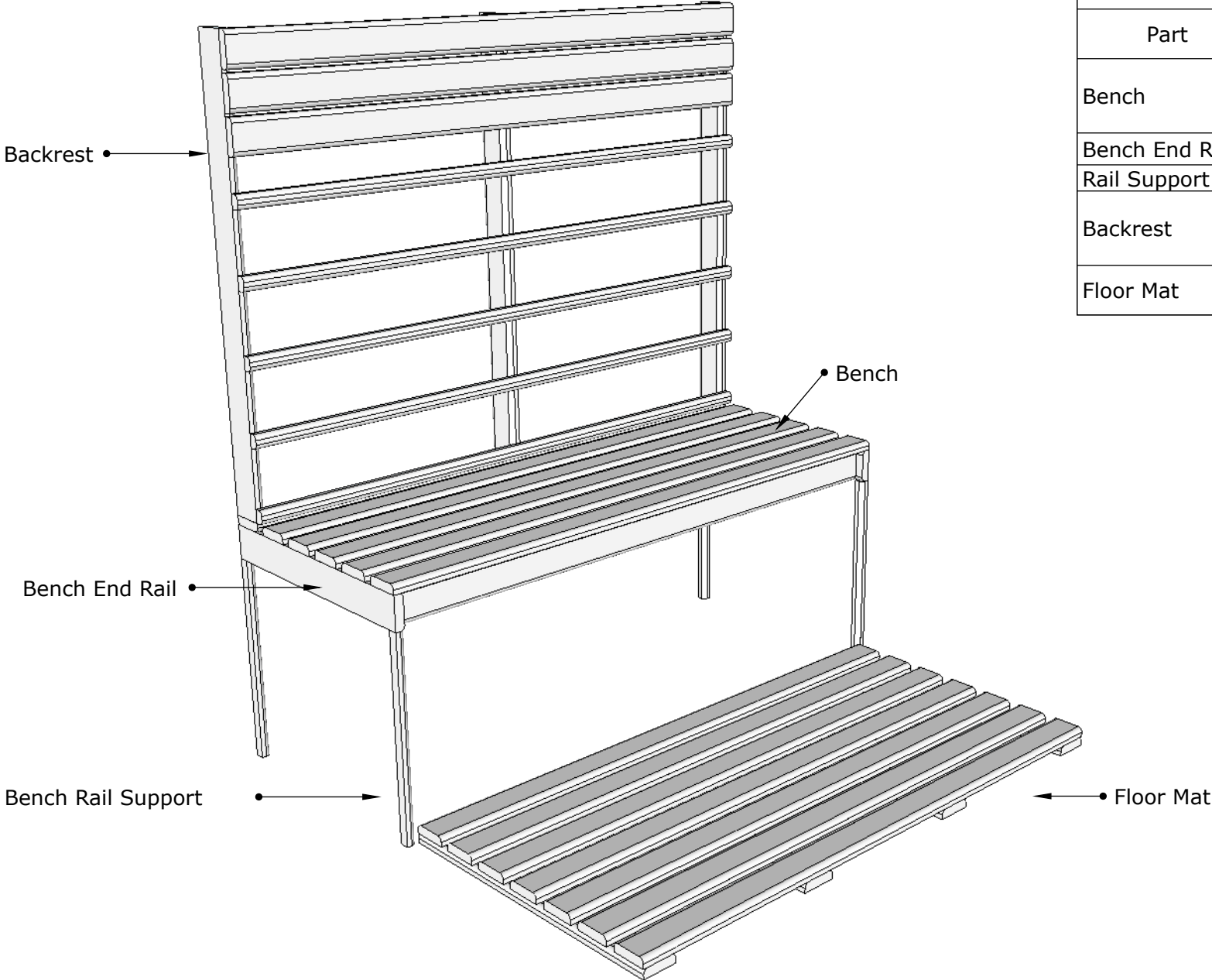

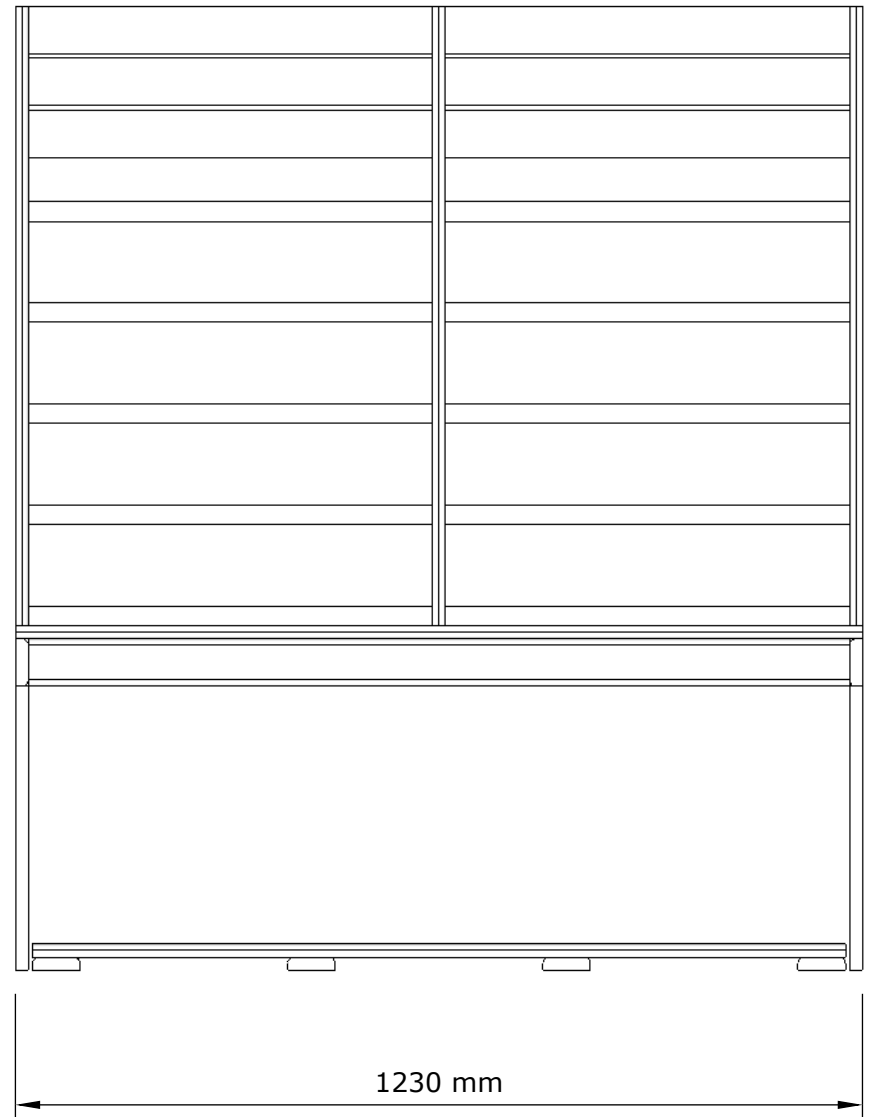

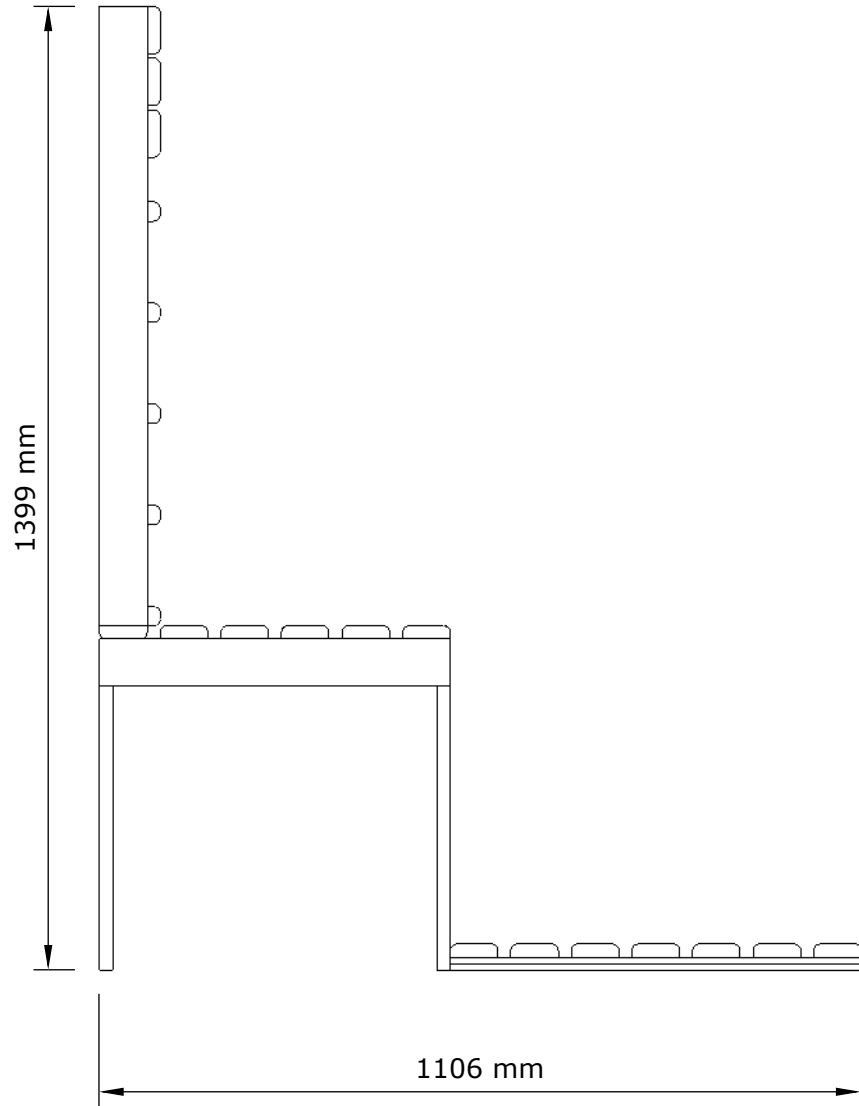
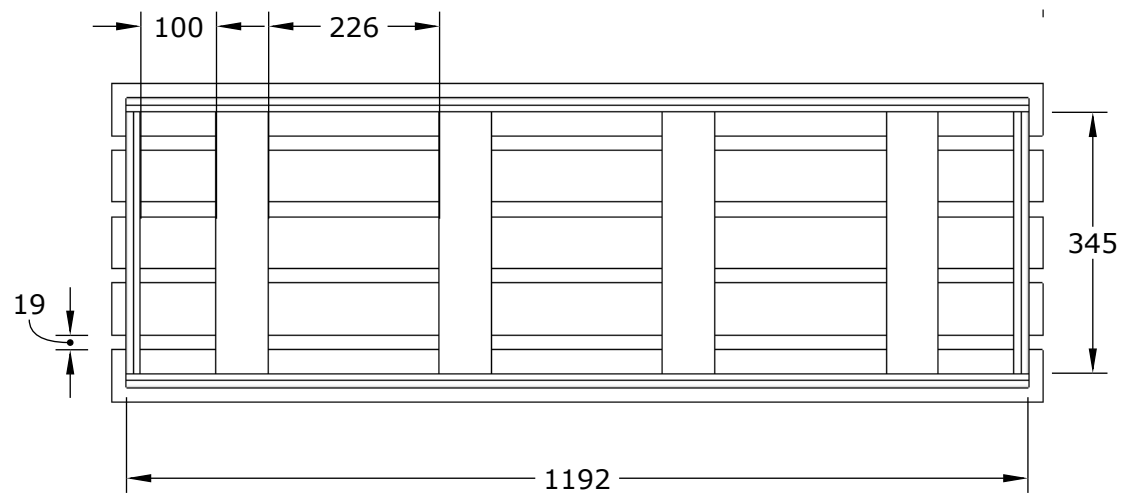
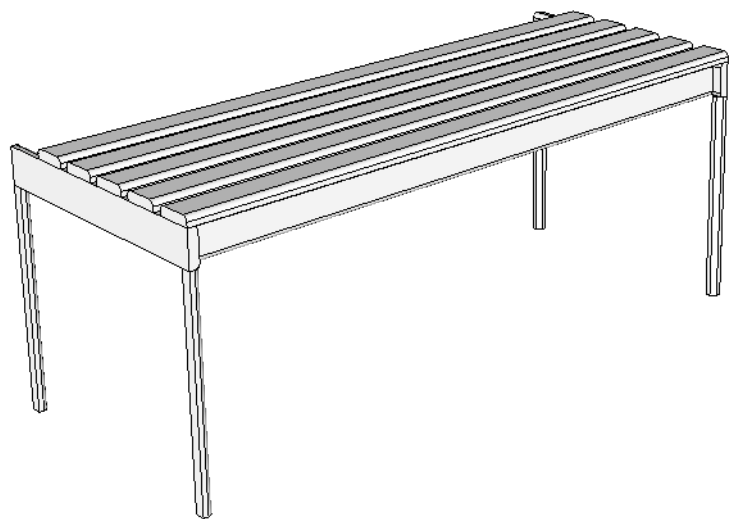
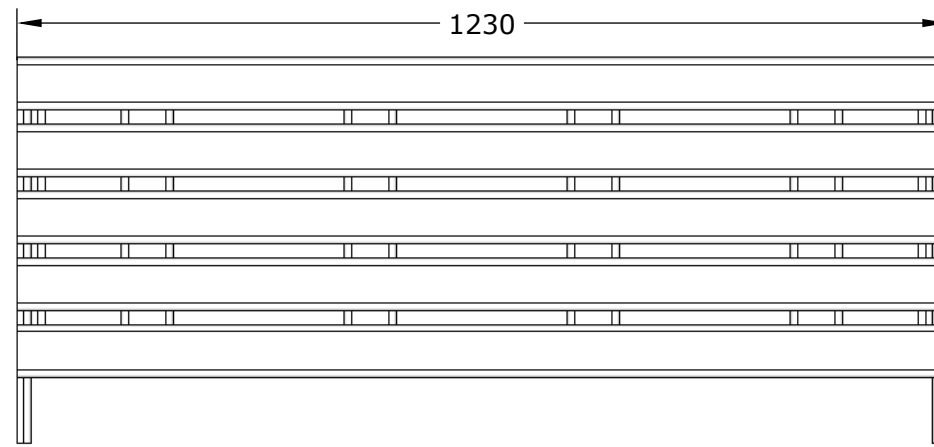
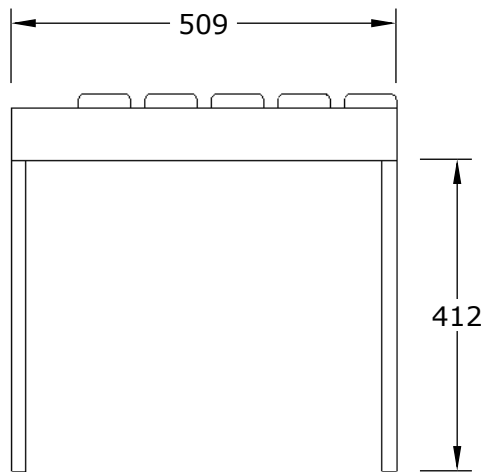

Scale 1:10 at A4

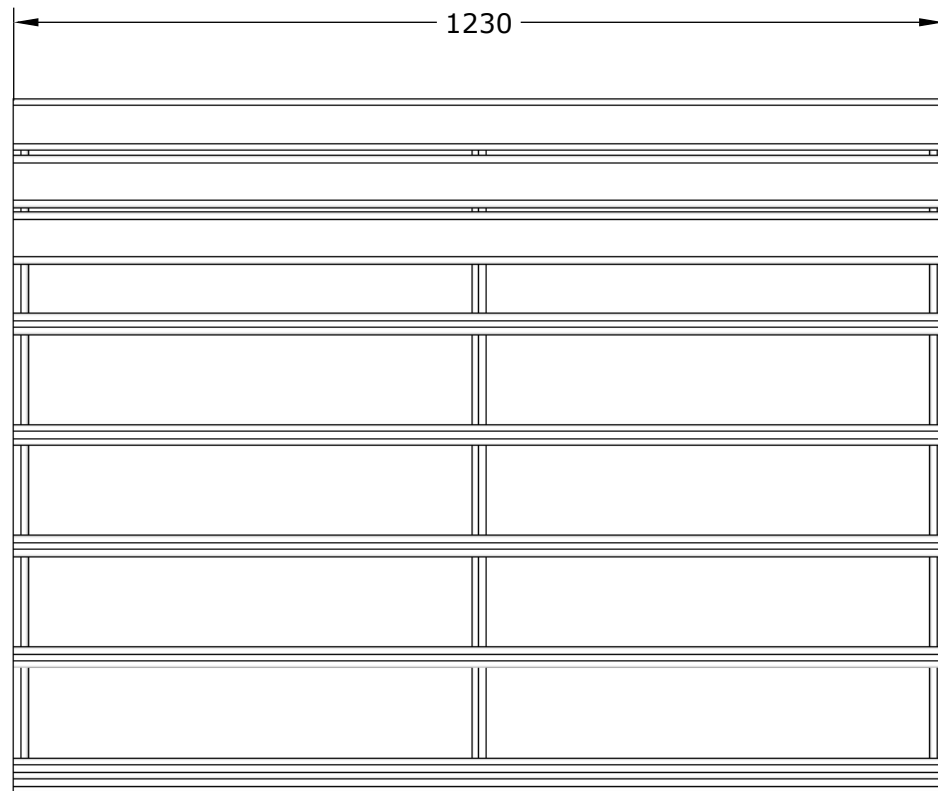
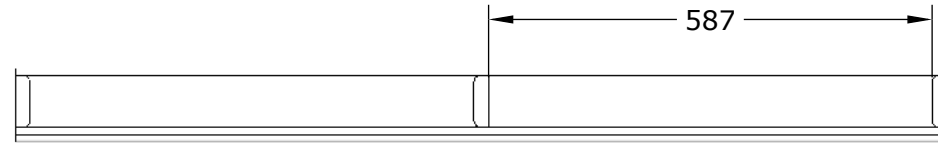
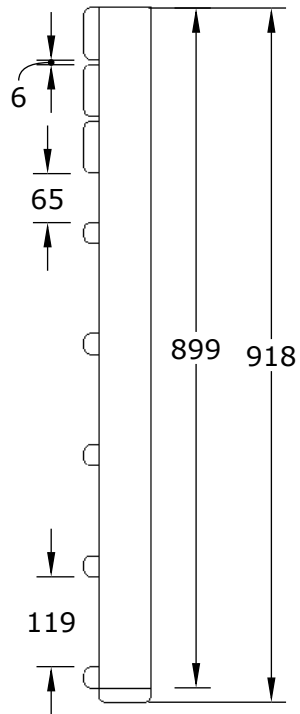
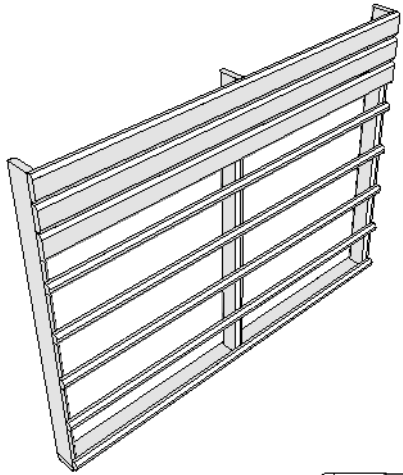

Scale 1:10 at A4

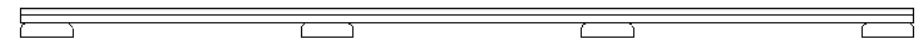
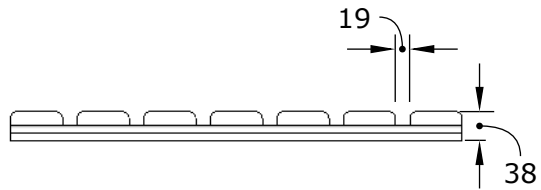
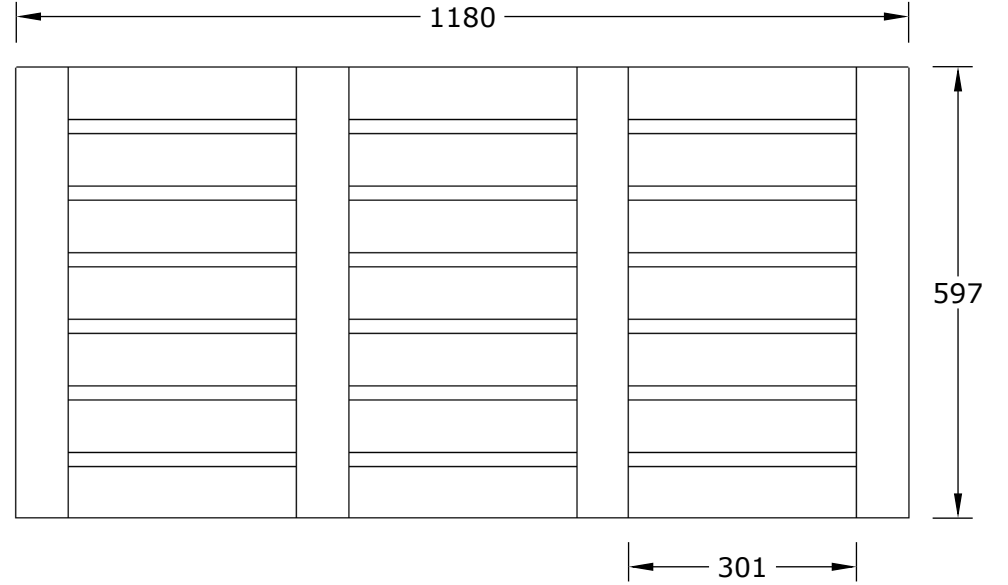
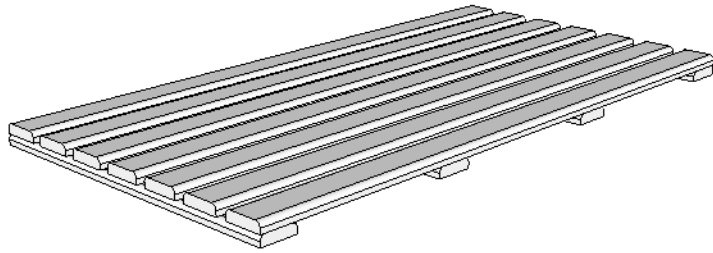

Scale 1:10 at A4