

Oceanic

Sauna & Steam

HEAVY DUTY SAUNA BEHIND BENCH HEATER INSTALLATION INSTRUCTION MANUAL



Contents

1.Introduction	1
1.1. Pre Installation Checklist	1
2.Tools you will need.	1
3.Wiring Panel	1
4.Construct base	2
5.Drill Corner Panel.	3
6.Fix Corner Panel	3
7.Add four corners	3
8.Add Cornice Trim	4
9.Add remaining wall panels	4
10.Install False Wall	5
11.Add door frame	7
12.Add infill section	8
13.Add roof panel	8
14.Add Corner Trim.	9
15.Add Bench End Rails	9
16.Add legs to end rails	9
17.Add overlap mould.	10
18.Add benches	10
19.Add back rests.	11
20.Fitting the glass door	11
21.Build floor mats	11
22.Add floor mats.	12
23.Add overlap mould.	12
24.Add uprights.	13
25.Add top facia.	13
26.Add final overlap moulds.	13
27.To reduce size of cabin. (All models).	14

1. Introduction

Welcome to the Traditional Sauna Bench build manual please take time to familiarise yourself with the steps to ensure a trouble free installation. Please note this is not a DIY kit and should be installed by competent tradesmen with skills of carpentry, plumbing, tiling and electrics. Please read through all of the safety precautions on the following page before using the steam room.

1.1. Pre Installation Checklist

1.1 Pre installation Checklist

This is not an outside sauna and can only be installed in doors or within a weatherproof building.

Saunas can be erected onto the existing floor that can be vinyl, ceramic, concrete but not carpet or wood.

The heater must be powered by an isolated electricity supply, please check the parts list for the KW of heater.

Check all the parts against parts list before commencing the installation.

2. Tools you will need

- A powered drill/screw driver with drill bits and posi screw bits
- 4mm Countersink Drill [Countersink all holes before screwing]
- Spirit level
- Hammer
- Hand Saw
- Optional Tools; Pin Gun, Cross Cut Saw, Large Set Square

3. Wiring Panel

As our cabins are supplied with digital controls we provide a special panel to conceal the wire. Please find the panel labeled "WIRING PANEL". The image below shows the channel down the centre of the panel, all wires are to run down this channel, the panel is supplied with no holes so it is down to you drill these where needed. Please see image below.

IMPORTANT NOTICE: Any wire entering the panel (Excluding temperature sensor cable) must be high heater silicone BSEN 6141 i.e Power Input, Heater or Light Cable.

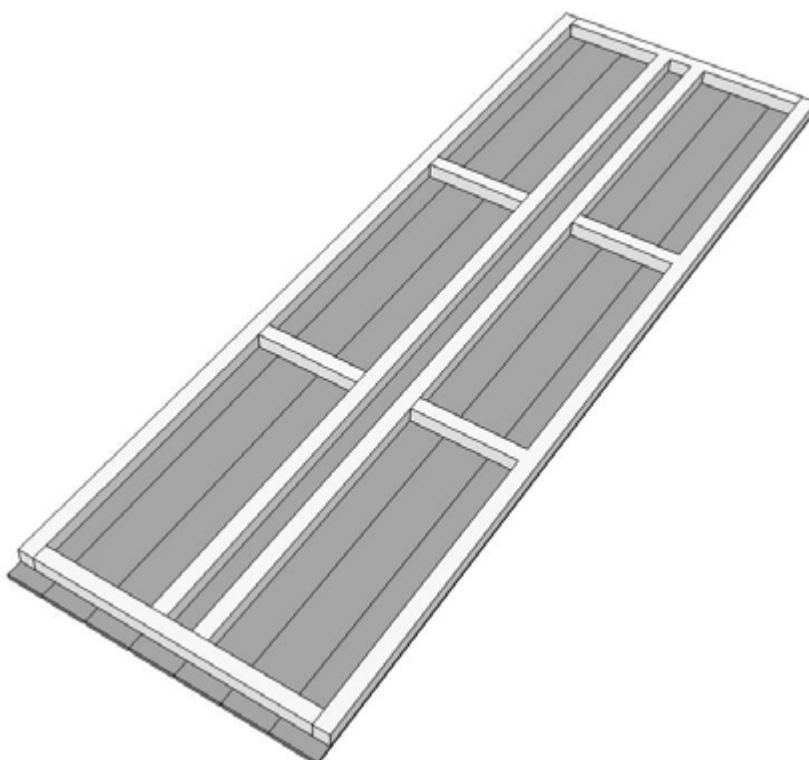

4. Construct base

- i. Lay out the four lengths of 78mm x 69mm base into the correct shape.
- ii. Check using the spirit level that all sides are flat.
- iii. Check that all corners are square using a set square and also by tape measure.

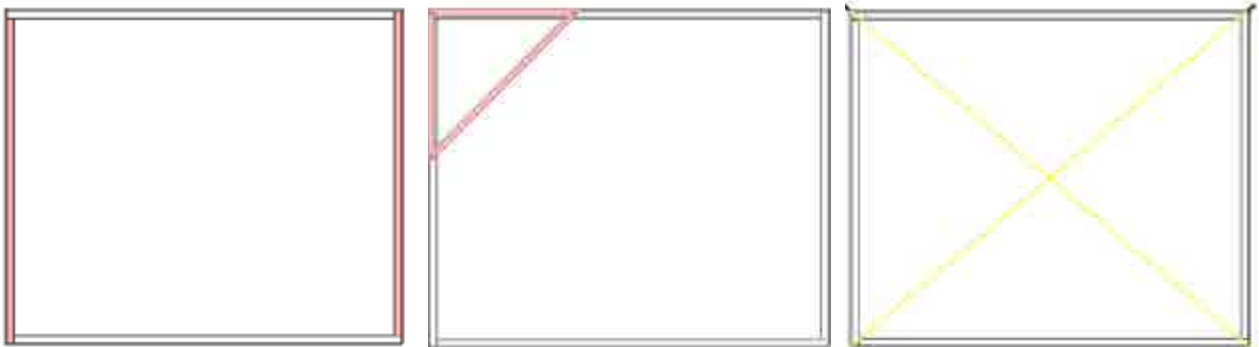
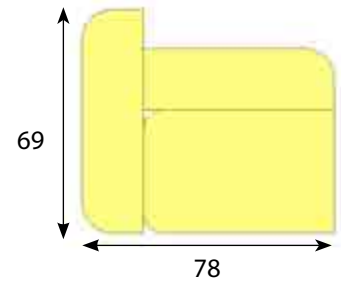

- iv. Measure the position of the door. Standard door frame is 905mm in wide. Check parts list for door position for your model of cabin.

- v. Cut out door position using wood saw.

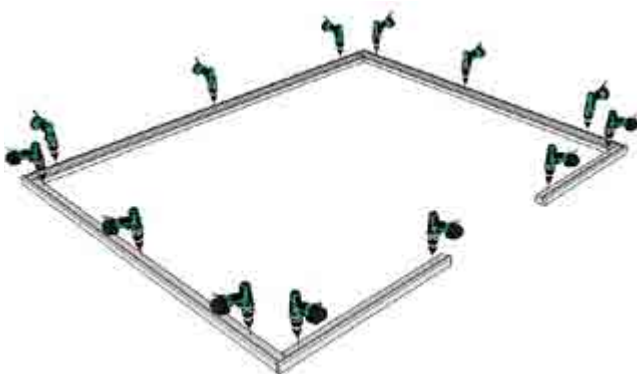
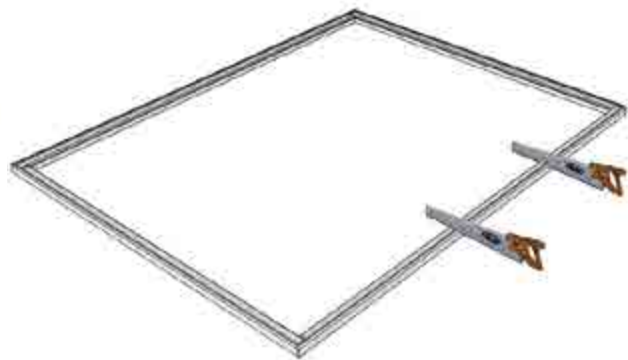

- vi. Fix the frame to the floor.

- vii. **Before drilling or screwing into any floor, check that there is no under floor pipes or wires and that the customer is happy for you to fix to their floor. If it is not possible for you to fix to the floor the base can be fixed together at the corners with 80mm screws and glued to the floor.**

5. Drill Corner Panel

- i. Stand up the panels which meet to form a corner.
- ii. Note that some corner panels may be vent panels, heat proof panels or even special sized panels (if you have ordered a bespoke sauna) so please make sure you are screwing the correct corner panels together, you can find this information from the parts list which is specific to each sauna.
- iii. Drill four holes along the corner of the side wall panels as shown in the diagram using a 4mm drill and countersink tool.

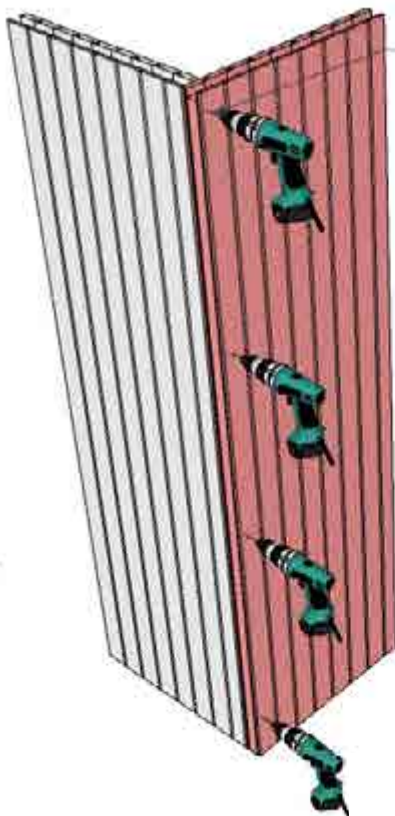

4mm Countersink



6. Fix Corner Panel

Fix the corner panels together using the 4 x 80mm screws.



7. Add four corners

Lift the corner panels onto the base with the void pointing upwards.

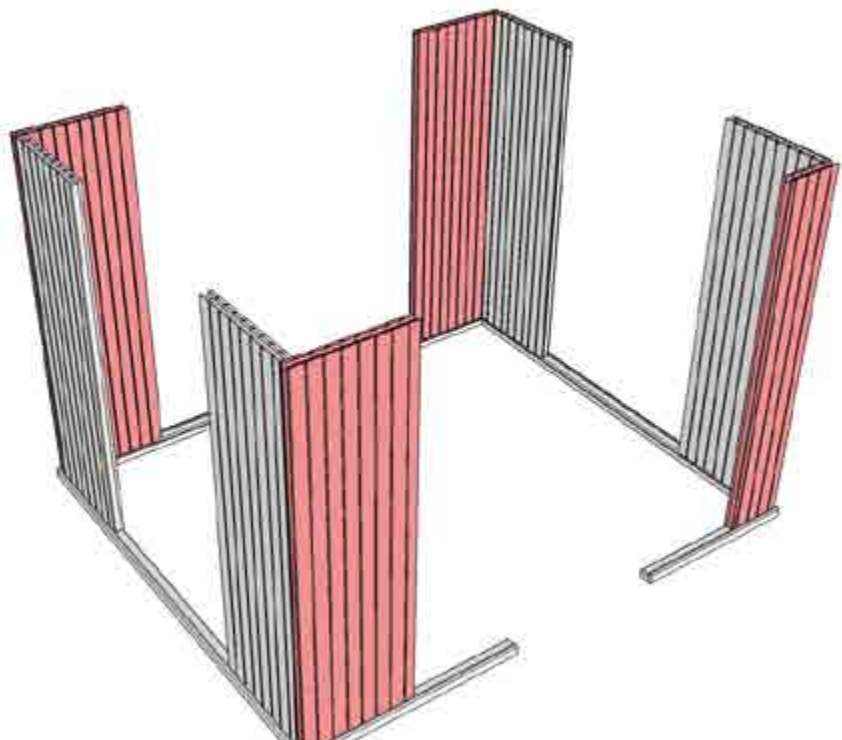

8. Add Cornice Trim

Fix the high level cornice trim (19 x 69mm) to the internal face of the corner panels as shown in the diagram using the 40mm screws or 35mm pins at 300mm intervals.

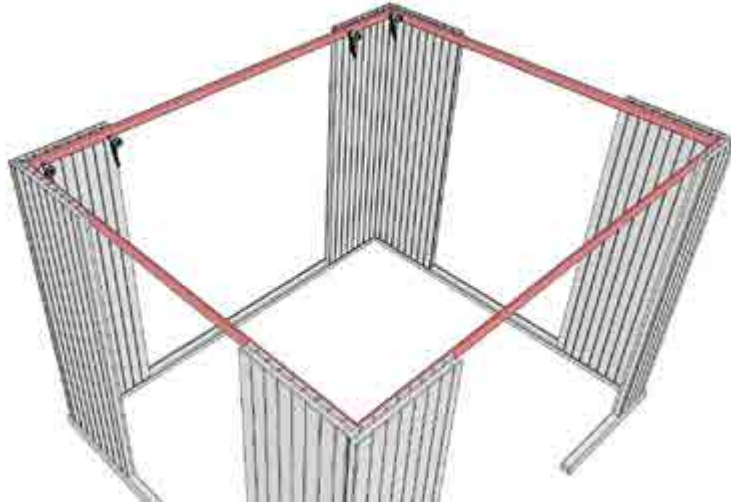
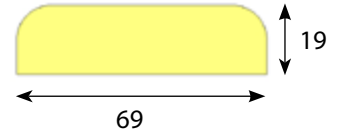

9. Add remaining wall panels

Position the remaining panels onto the base and fix to the cornice trim.

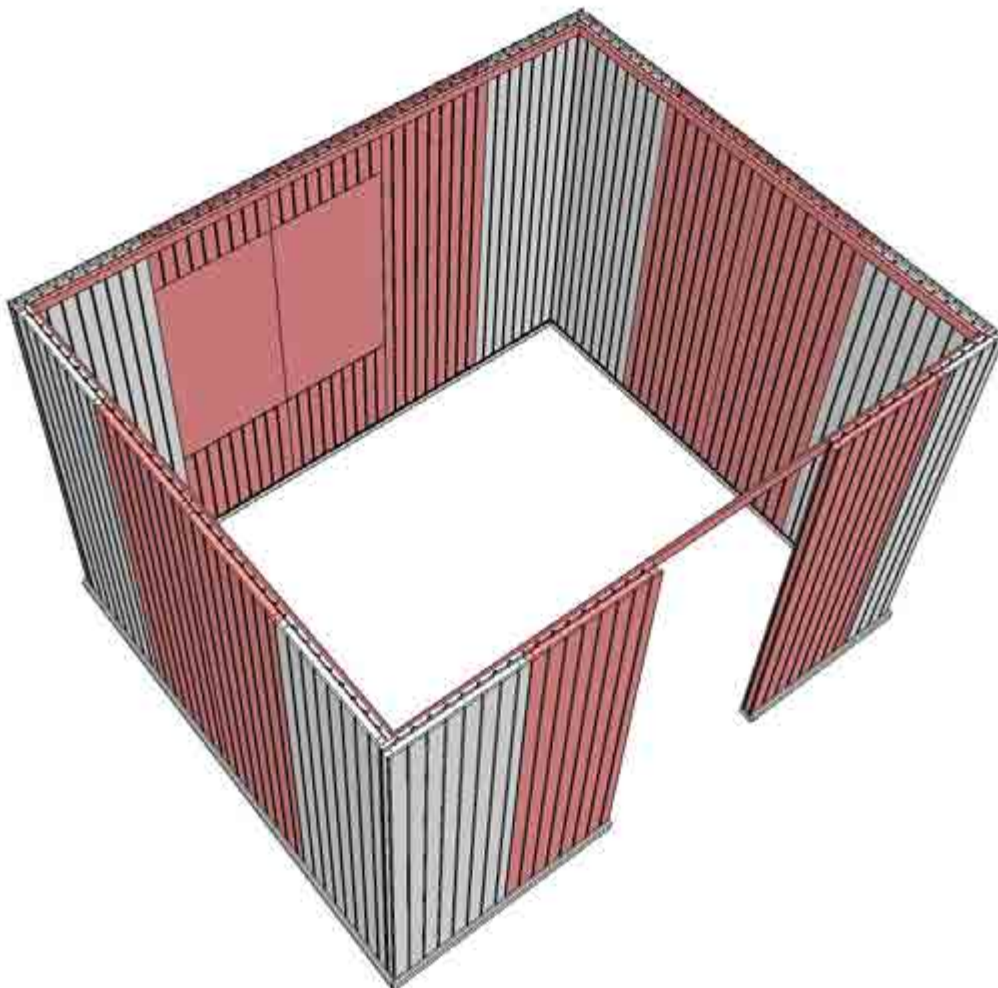

10. Install False Wall

- i. Fix false wall panels to the base section 63x38mm with 80mm screws and length of fascia section 69 x 19mm on the top using 40mm screws.

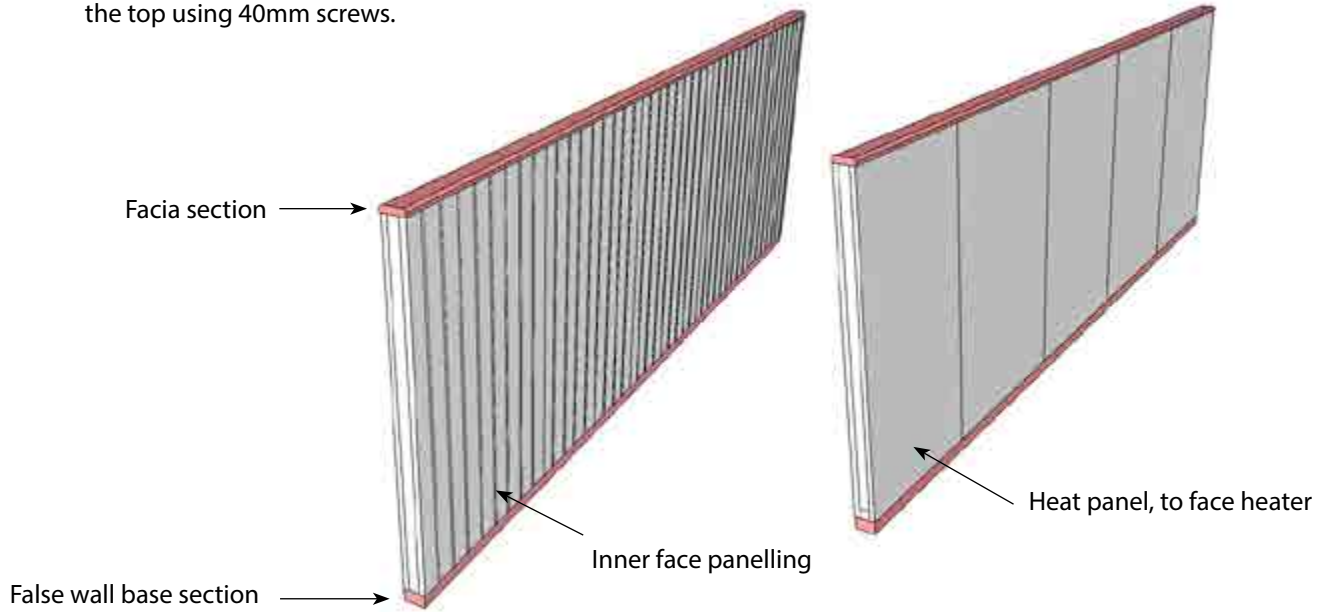

- ii. Install vertical brackets for false wall

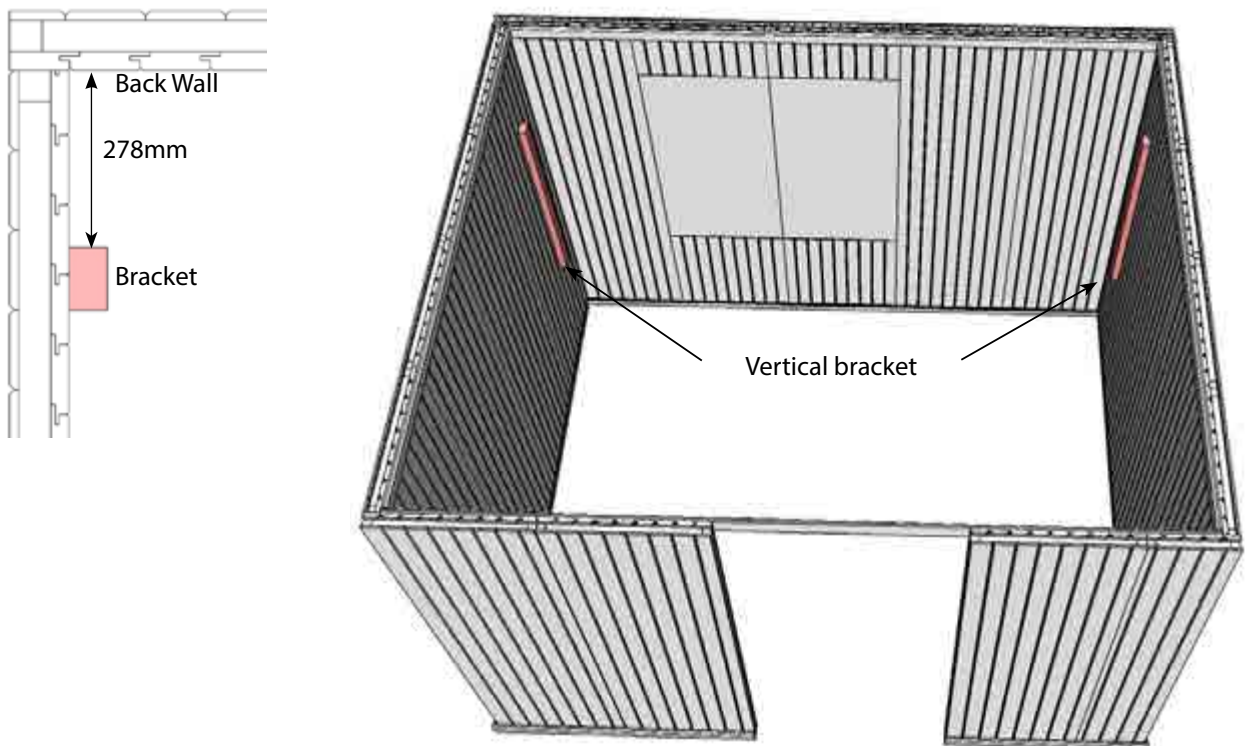

- iii. Install behind bench heater against back wall. (see behind bench heater manual for further instructions - page below taken from manual)

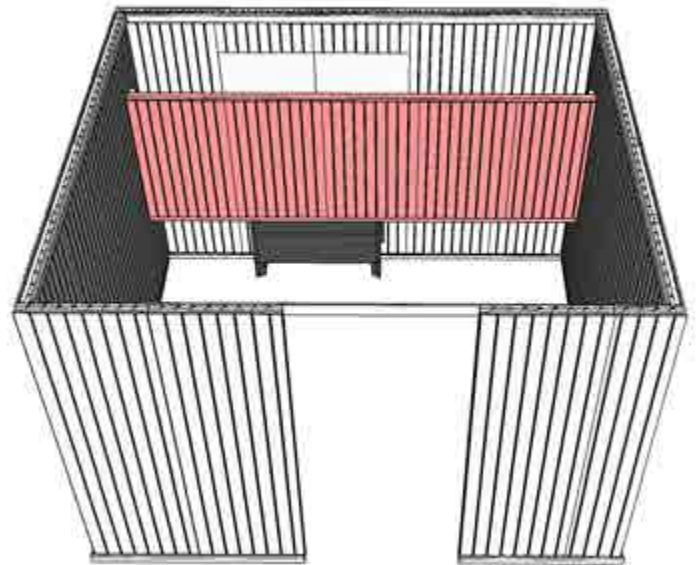
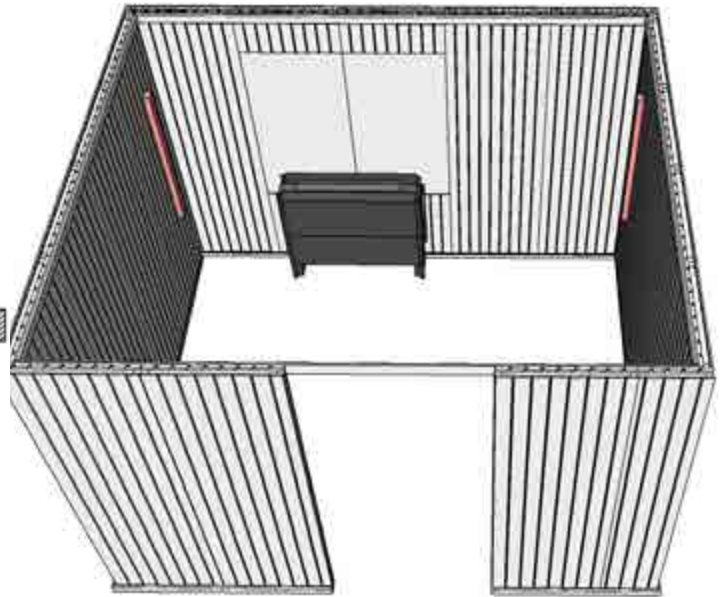
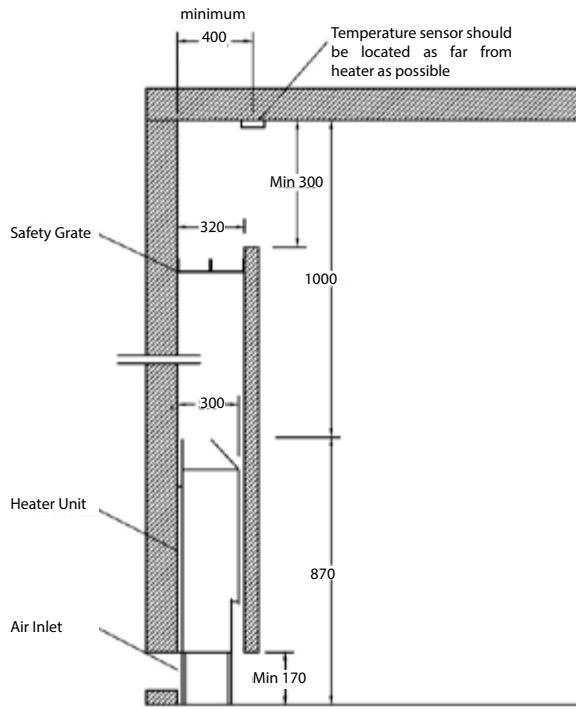

- iv. Fix false wall to vertical brackets using 40mm screws

- v. Add heater grate, water pipe and dish behind the false wall.

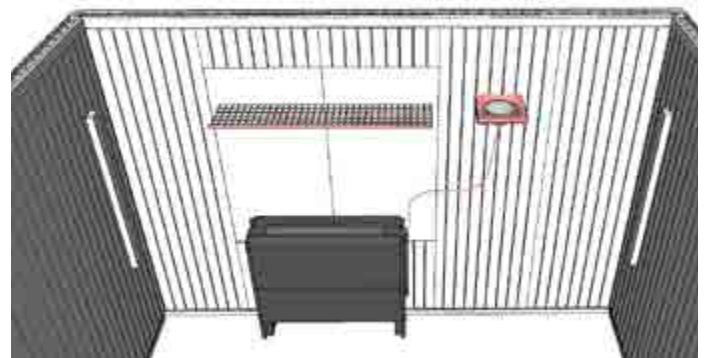

11. Add door frame

Note: When handling toughened glass, safety goggles should be worn.

- i. Use 4 x 50mm screw either side to screw the door into the walls. (Use 4mm countersink for holes)
- ii. The door must be installed opening outwards, if you want to change the direction of the swing first rotate the frame by 180°, shown in right image.

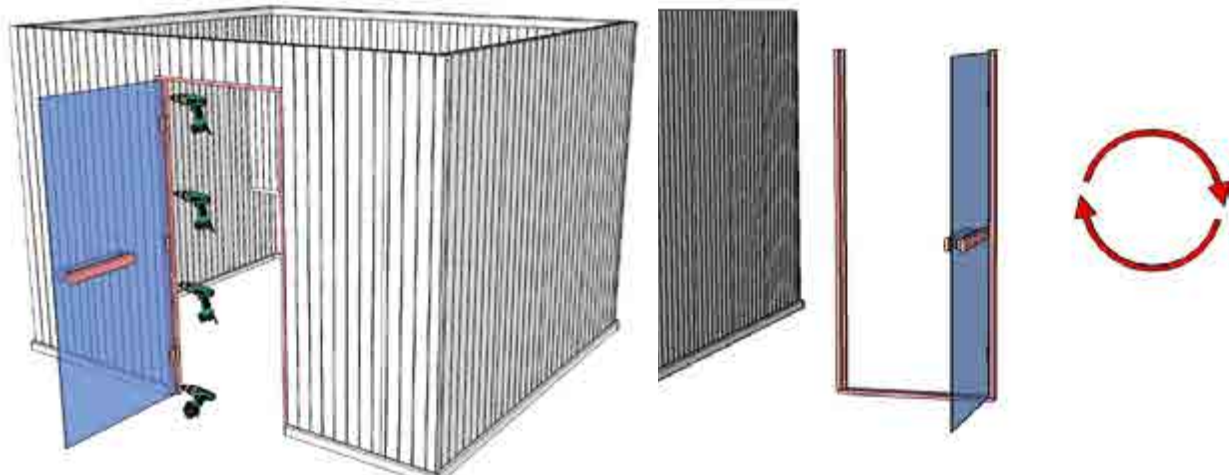

- iii. Unscrew the rail and move from the bottom to the top shown in left image below.
- iv. Unfix the glass from the hinges and rotate 180° as shown in the image to the right.

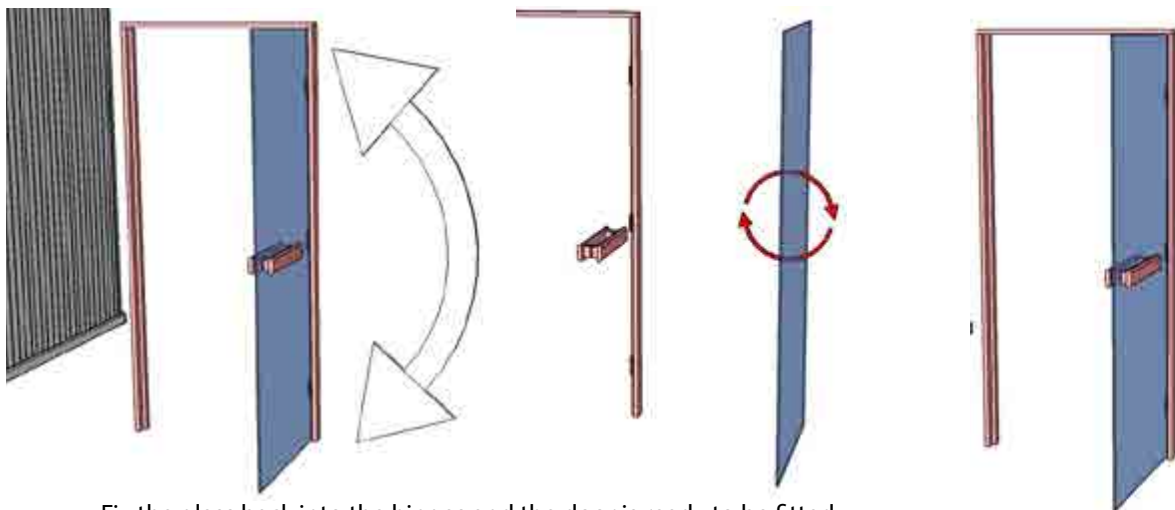

- v. Fix the glass back into the hinges and the door is ready to be fitted.
- vi. When installing the door if you are experiencing trouble with it closing square, it may help you to install the ceiling panels first or wait until you are installing the ceiling panels to level the door.
- vii. Fix the door handle so the caps are on the exterior of the cabin.
- viii. If you are installing the door in the corner, we advise to use a piece of corner mould to finish the inside edge of the frame.
- ix. Add in fill panel above door as shown below with 3 x 50mm screws.

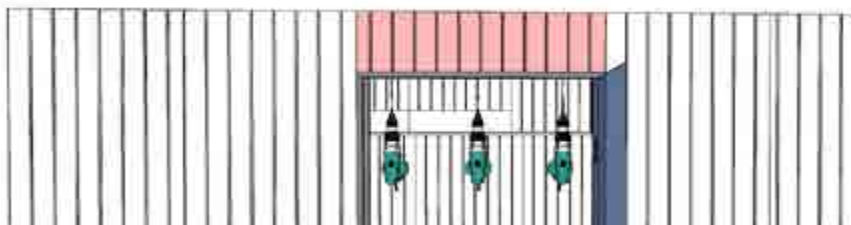

12. Add infill section

- i. Place the 20x32mm infill section into the recess on top of the wall panels.

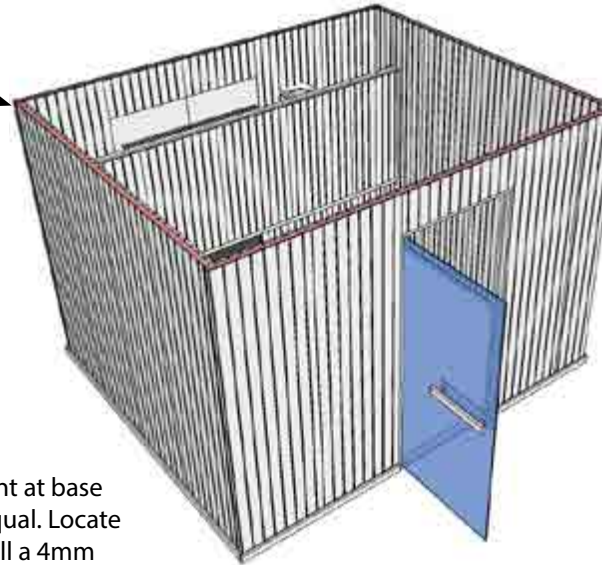
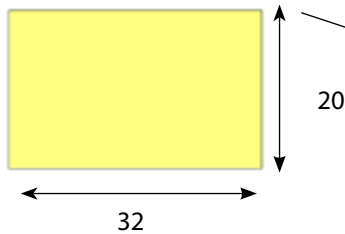

13. Add roof panel

- i. Fitting the roof; first check diagonal measurement at base to ensure cabin is square i.e. Diagonals will be equal. Locate roof panel flush to side and front edge. Firstly drill a 4mm dia hole and fix using 4 x 40 mm screws – approx 300mm intervals
- ii. If there is space above fix down from on top. Alternatively fix internally up through the cornice.
- iii. Repeat for all roof panels. Heat proof panels should be positioned above heater as shown.

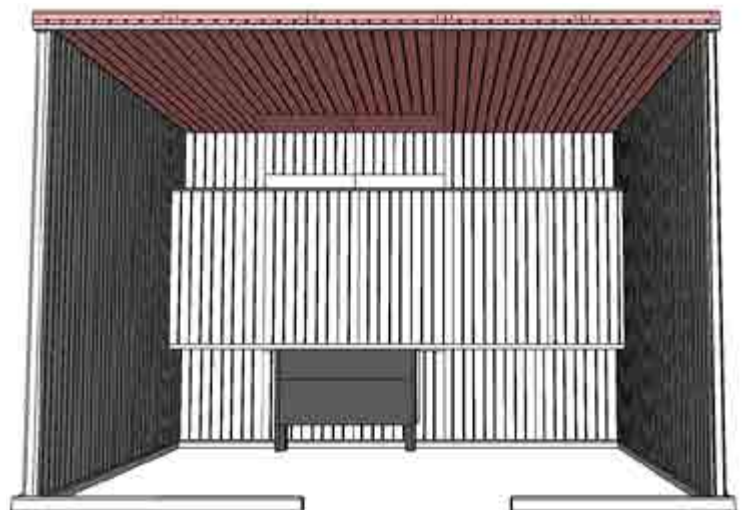
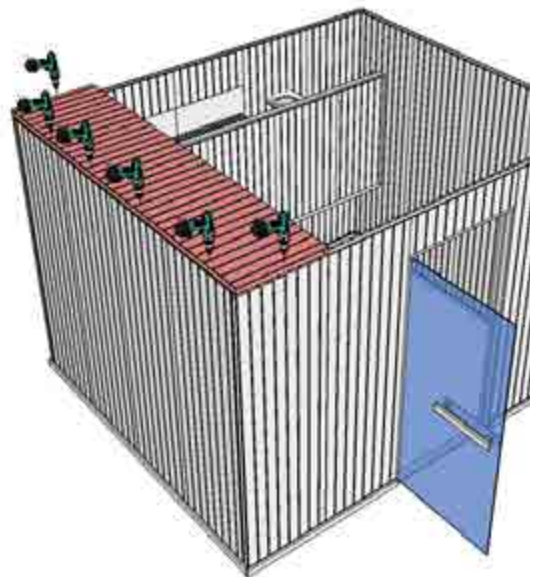
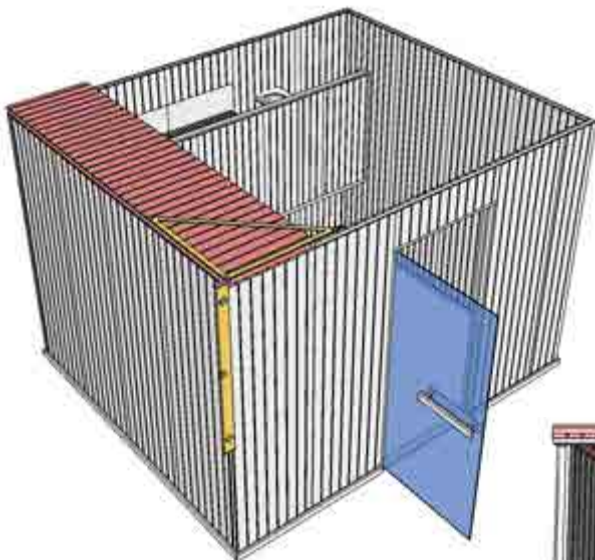

14. Add Corner Trim

Use nail gun to fix the internal vertical corner trim (19x19mm) into the internal corners of the structure and around the door frame.

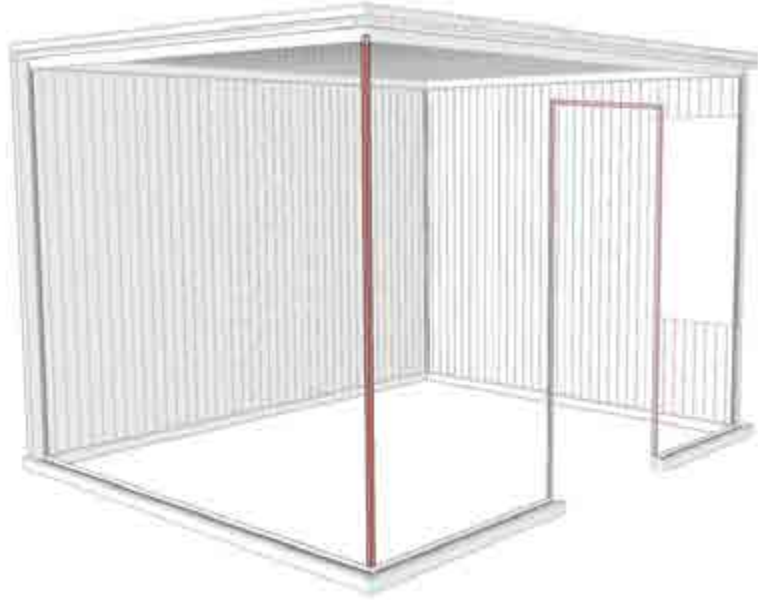
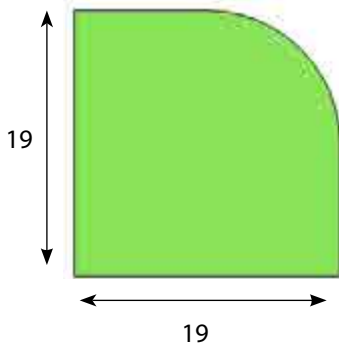

15. Add Bench End Rails

Fit bench supports; all timbers fixed to cabin walls with 6 x 40 screws, ensure fixing screws pick up main framework in panels (if in doubt add additional support beneath rail). Please use the parts list to position the rails correctly, the next page shows the accurate sizes of the lengths of timbers and height they should be fixed off the skirt. **The strength of these fixings is critical as the weight of the user is carried by such.**

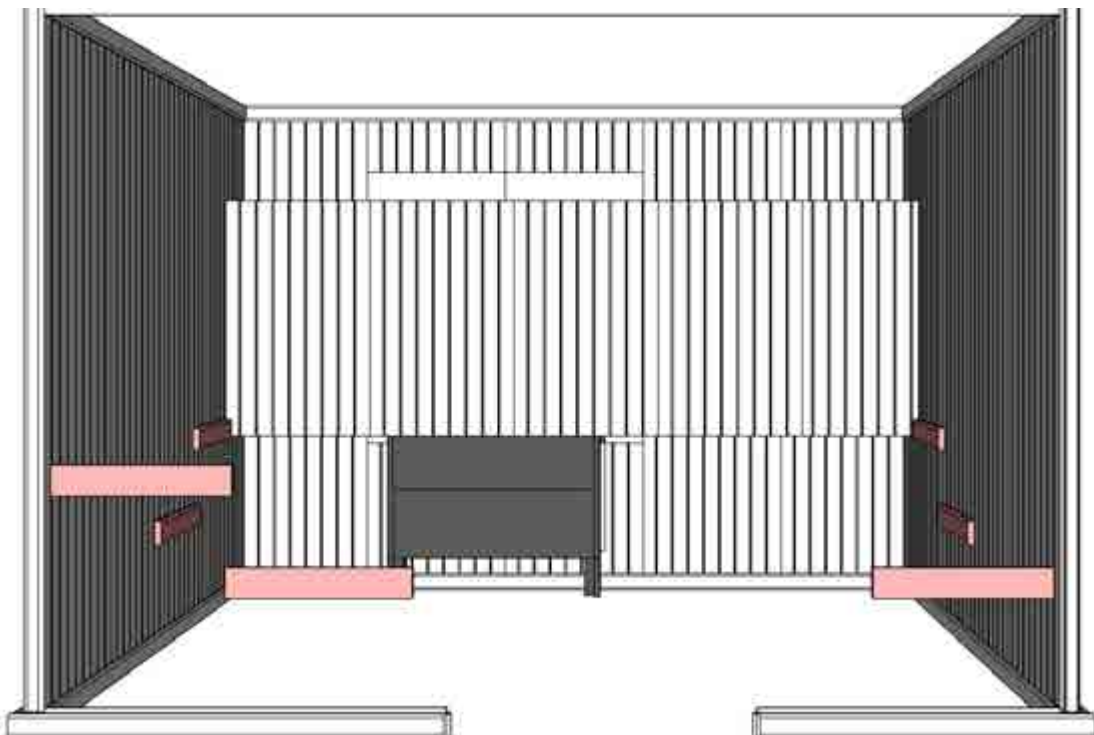

16. Add legs to end rails

Fix legs to the wall panels in position beneath each end of the rails using 60mm screws

Low Support

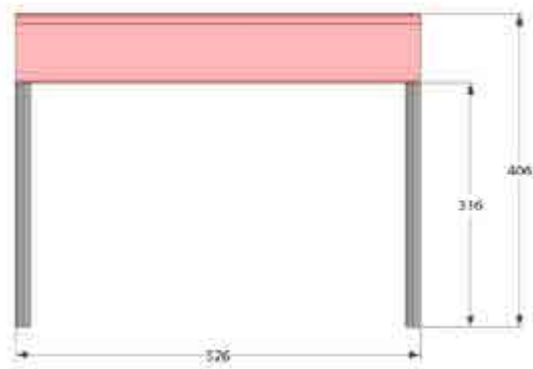

High Supports

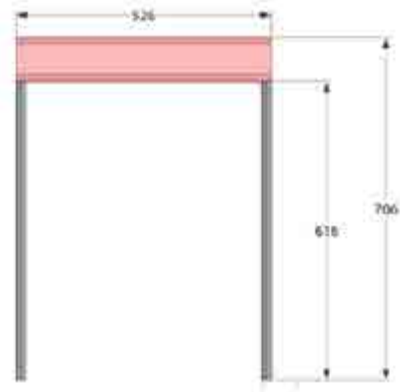

High and Low Supports

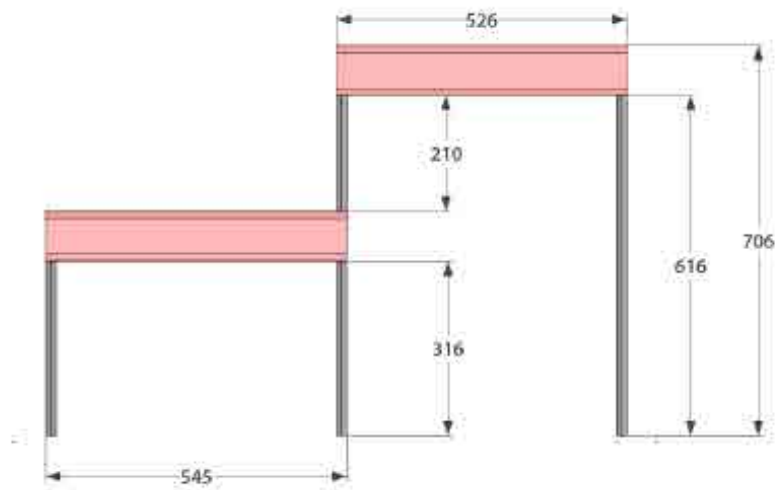

17. Add overlap mould

Nail the overlap mould over the wall panel joints.

Where the overlap hits a bench rail finish the overlap 25mm above the rail so that it fits neatly above the bench once installed. You can fit the overlap after the benches are installed if you prefer.

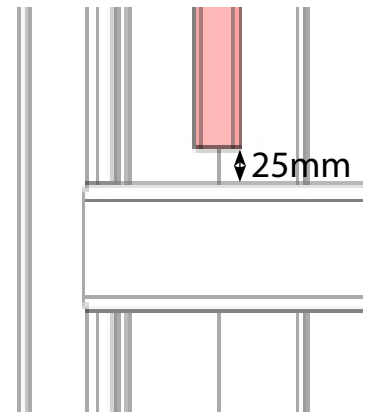
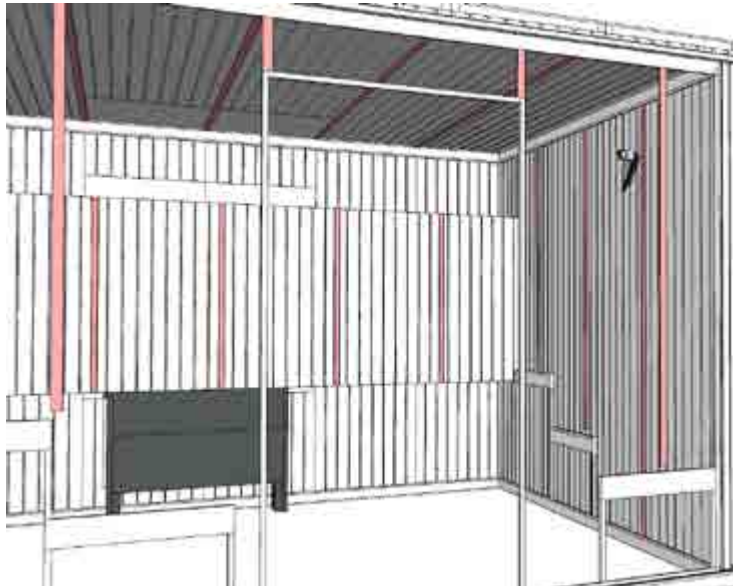

18. Construct under frame (Part 2)

Before commencing the construction of the benches find the specification sheet for the sauna you are building. This will give detail of the correct quantities and positions of timbers and fixings.

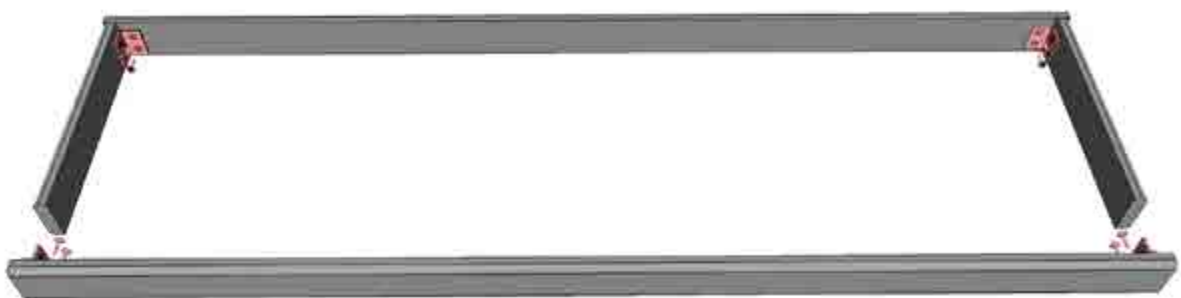

- i. Screw the supporting frame together using the 4 large brackets and 20mm screws.
- ii. If the sauna you are building has L shaped Benches where one bench end fixes against a perpendicular bench then your frame should be constructed as shown below with one end doubled up. Looking at the

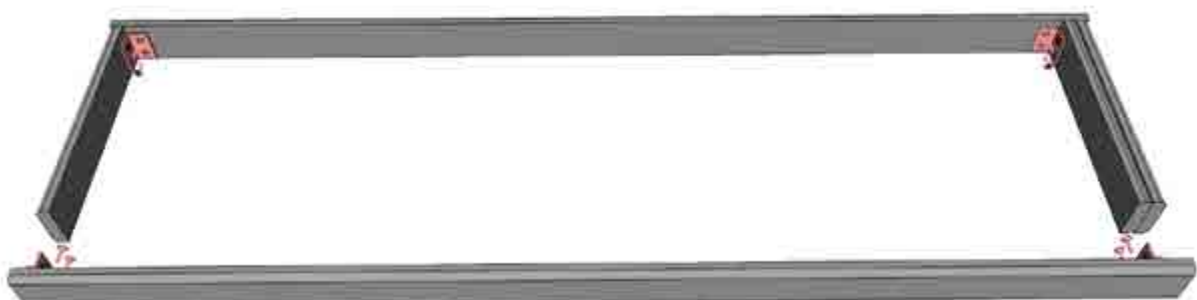

parts list or a few pages forward may help to understand this better.

19. Use workbench with square corner

- i. Lay the 5 or 6 bench slats face down on a work bench, use two pieces of scrap timber along the edges

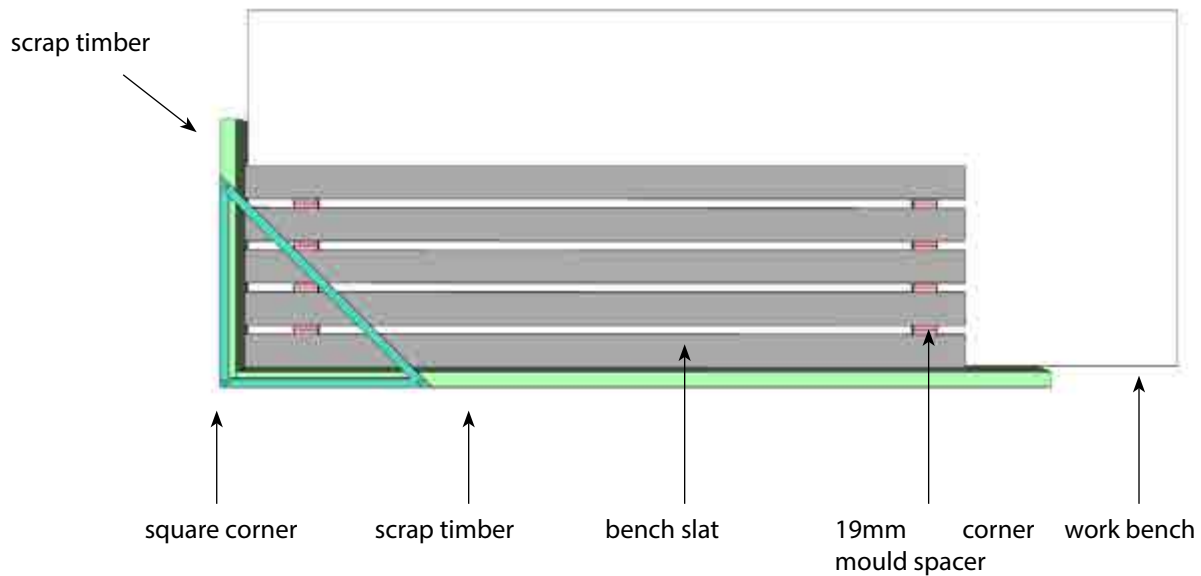

of your bench to create a square corner to work off. Use small pieces of corner mould as 19mm spaces.

20. Add supporting frame

Lay the supporting frame onto the slats, use the 25mm spaces supplied along the two edges to give a 25mm overhang on the end and edge of the bench. (If you can't find the spacers use any piece of 25mm timber -

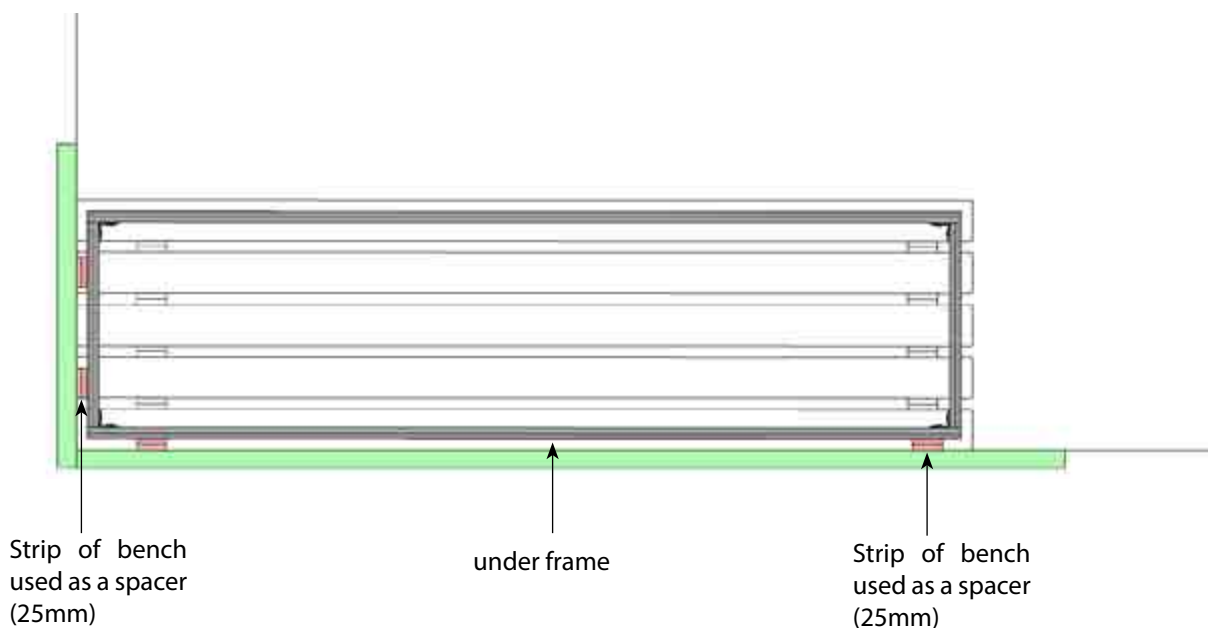

L Bench (Fixes to Wall one end, bench the other)



Overhang sits underneath perpendicular bench slat

Bench end rails part 4)

21. Cross members

Add the cross members, two are positioned 100mm from the ends, the third is centred, a dimension for A can be

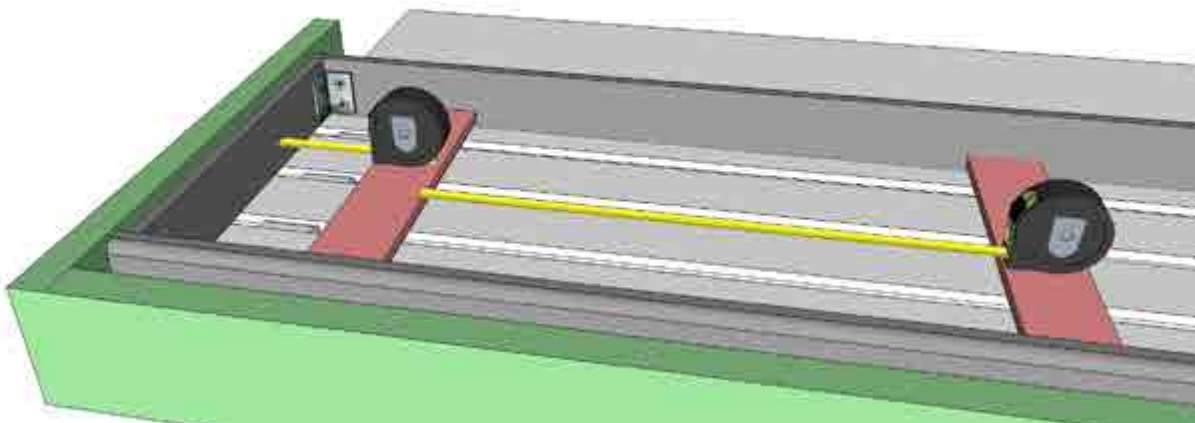
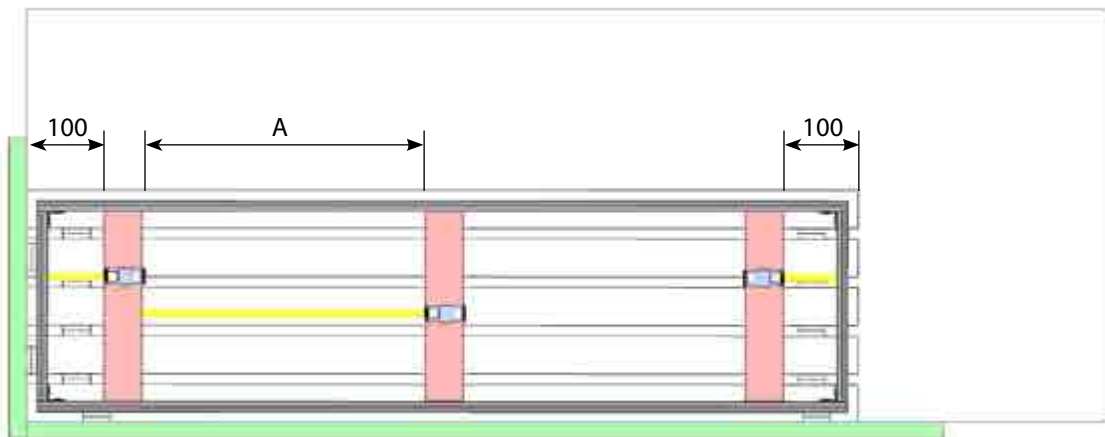

found on your specification sheet.

22. L brackets



Evenly space out the 14 L brackets and fix using 20mm screws.

23. Fix cross members

Use the 30mm screws provided to fix down through the cross members into the slats.

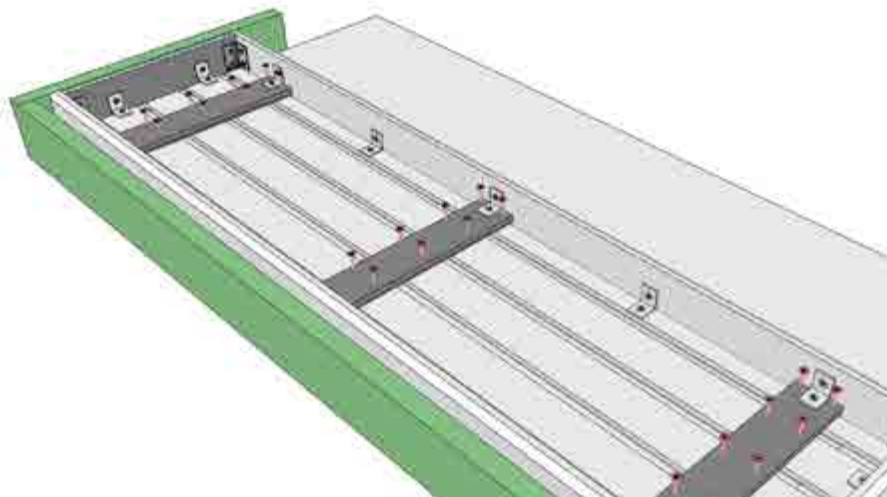

24. Add lower or higher leg support.

Make sure you fix the correct size of leg support, see the parts list for details. Fix with 6x 40mm screws.

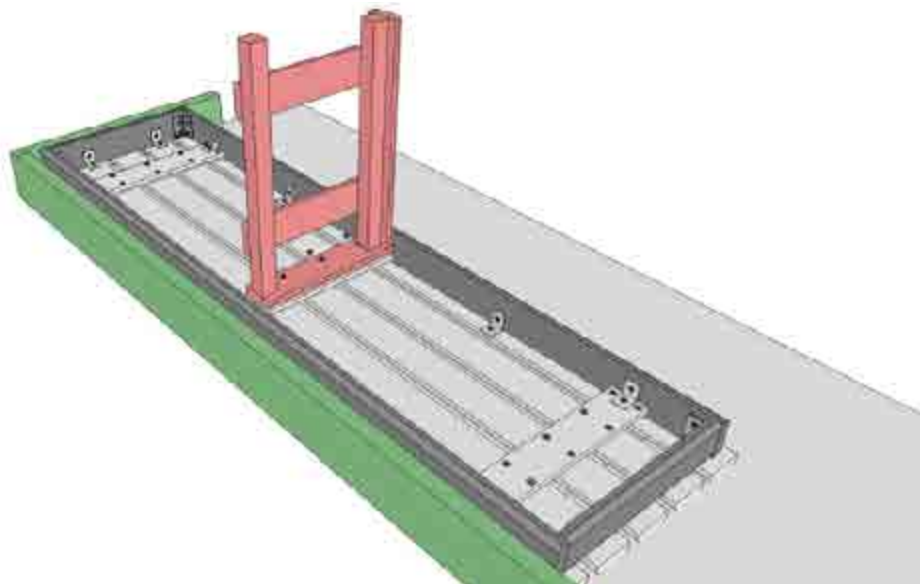

25. Add benches

- i. Refer to bench build manual and drawings to construct the benches
- ii. Locate the overhanging section of bench onto the supports and drill 2 x 4mm holes into the underneath section of the end rails of the bench and fix using 2 x 40 mm screws into the support rails.
- iii. For benches over 1300 mm centre supports are provided, fit the centre legs supports prior to hanging the benches.
- iv. If there are more than one bench at either level install the full length benches (rail to rail) first.
- v. Add the next bench at right angle to the first (rail to bench) fixing through the end of the bench into the bench end rail and side of first bench.

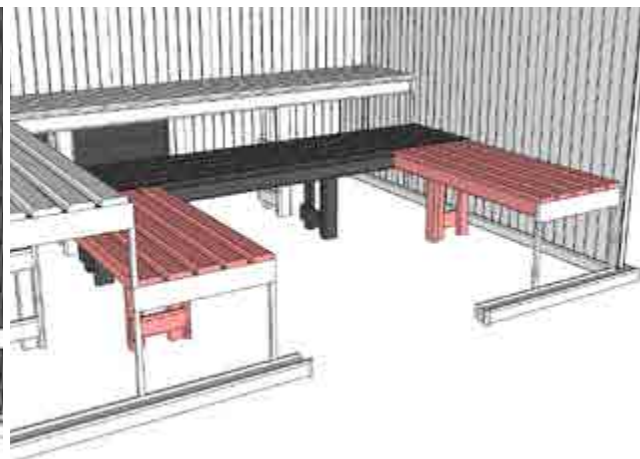
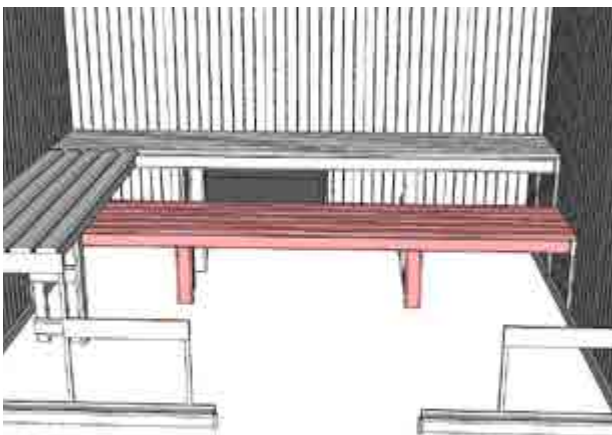
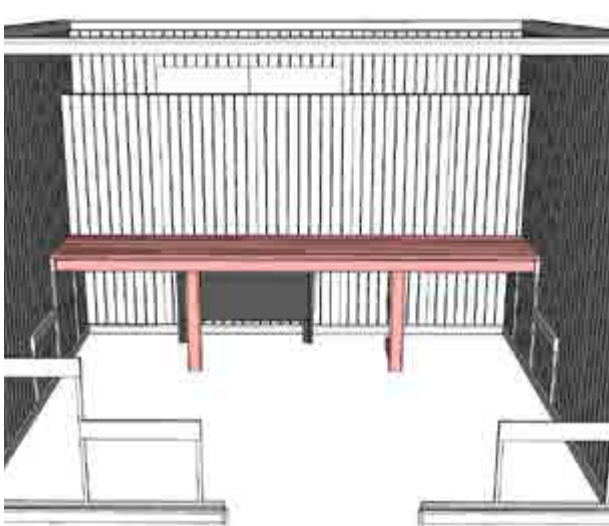

26. Add back rests

Install the back rests at a height of 250mm from the top of the bench to the bottom of the back rest using 50mm screws.

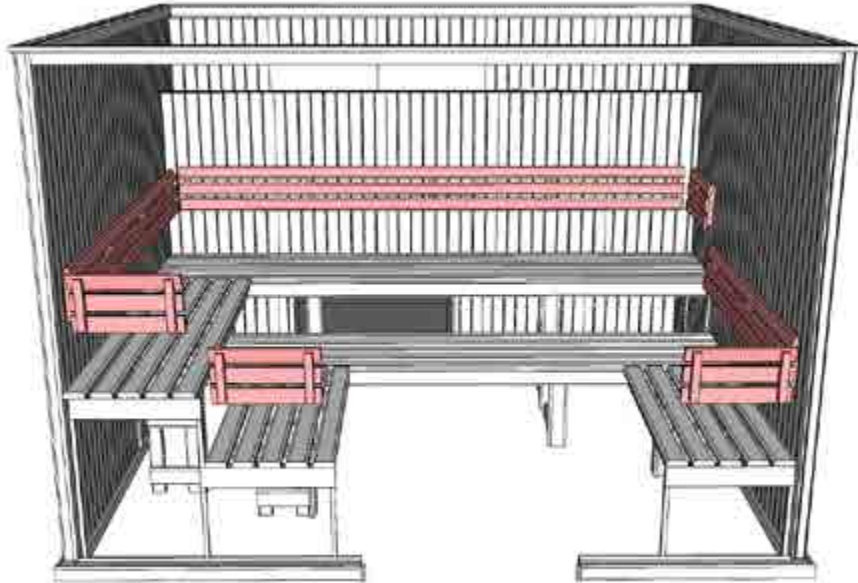

27. Build floor mats

You will be provided with pre-cut timber to create a floor in which to cover the area in front of the benches and underneath the heater.

Please make sure you measure the area first and make sure you have built the cabin correctly for the mat to fit. Assemble the floor mats using left over corner mould as 19mm spacers between the slats.

Ensure the cross lengths aligned equally beneath the length of the mat as shown in pink in the diagram below. Fix with glue and 30mm screws from the underside remembering to countersink all holes.

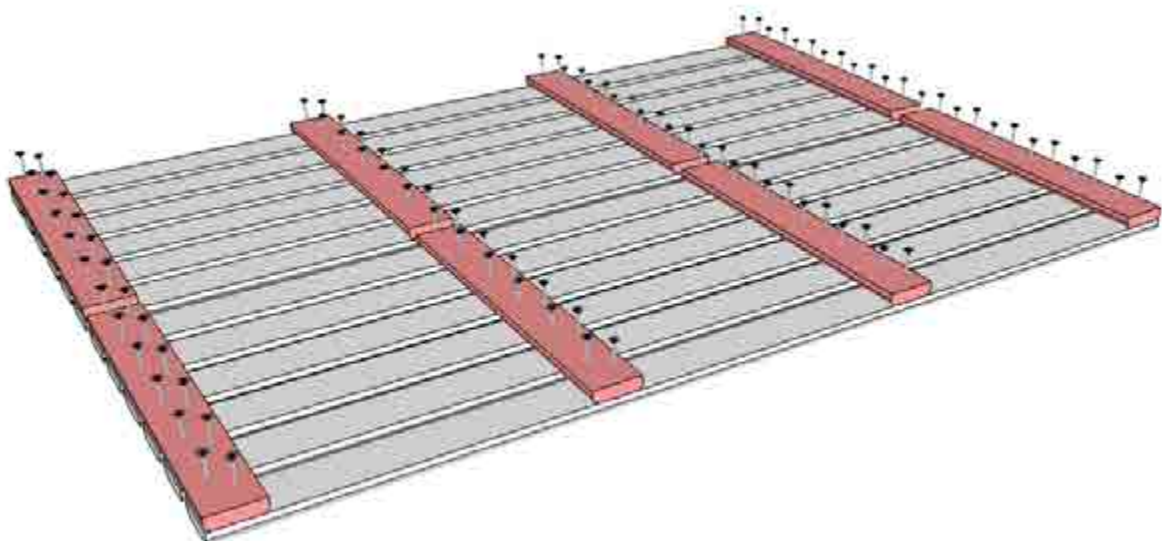

28. Add floor mats

Position the floor mats in the sauna room, no fixing required.

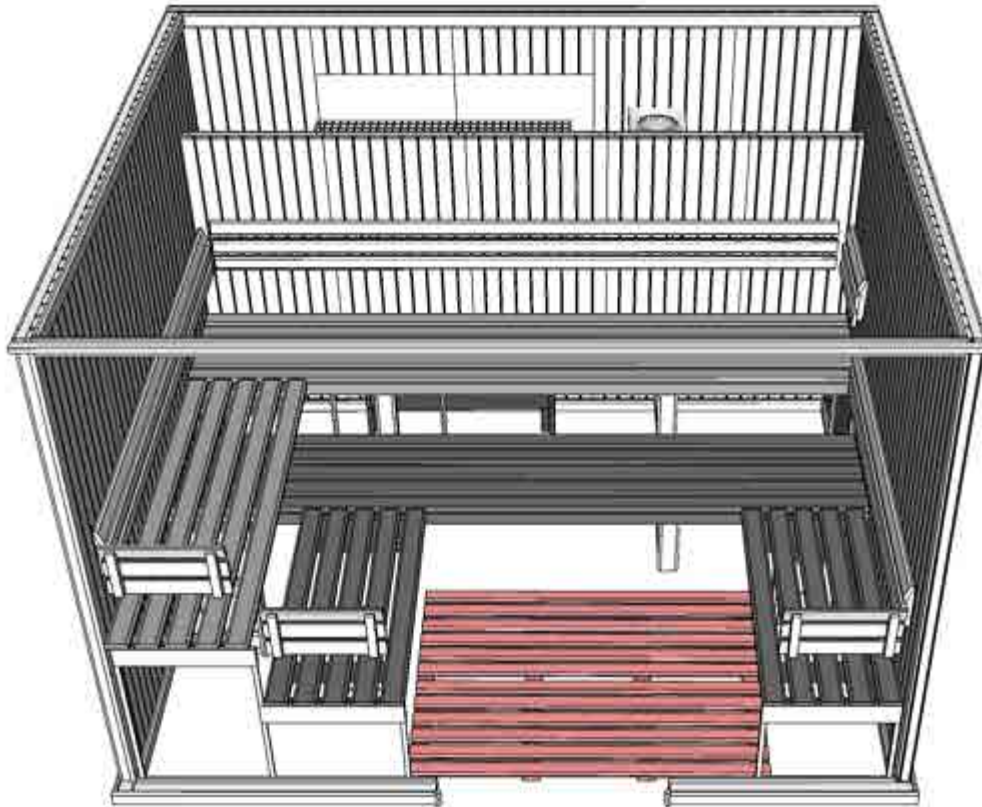

29. Add uprights (Part 12)

Cut and fix the (69x19) fascia uprights on the corners of the sauna. Fix with 32mm Pins.

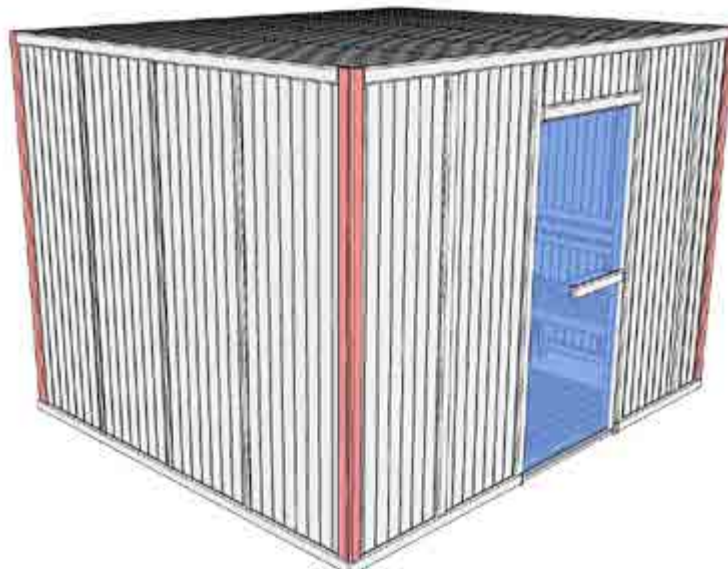

30. Add horizontal fascia (Part 8)

Cut and fix horizontal (69x19) fascia in between the vertical uprights. Use 32mm pins.



31. Add intermediate trims between the top and bottom fascia (Part 7,8,12)

Measure and cut lengths of fascia between the top and bottom trim and across the top of the door frame. Use (69x19) fascia for the front and (32x9) overlap for sides. Fix using 32mm Pins.

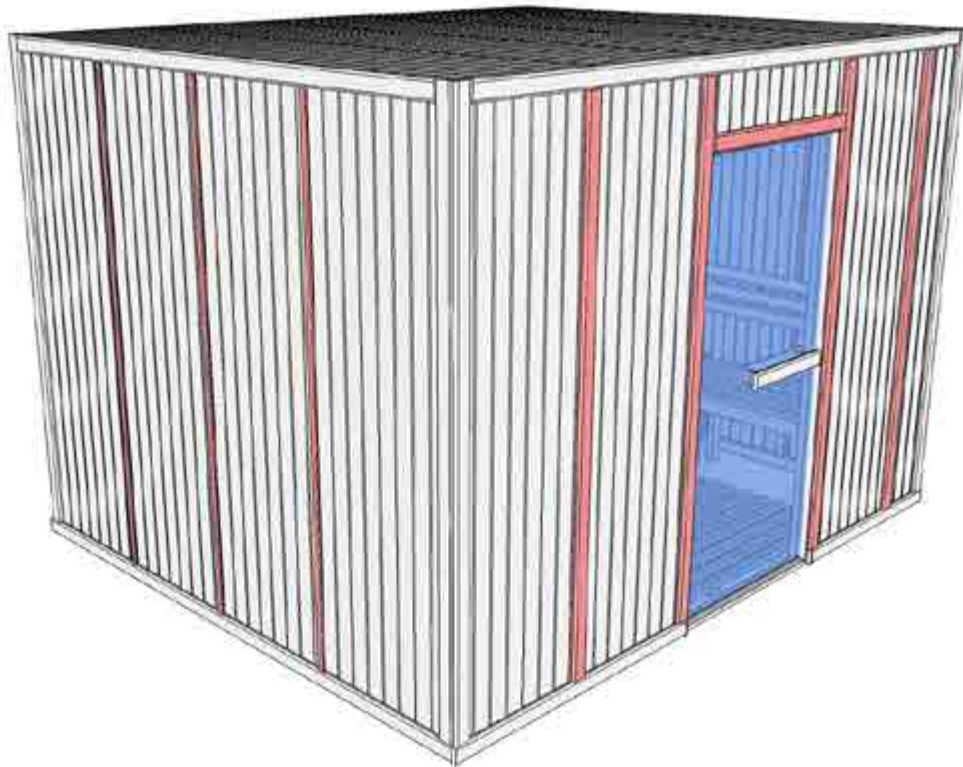

32. To reduce size of cabin. (All models).

IMPORTANT NOTES (SAFETY CRITICAL)

- At all times the clearance distances around the heater must be complied with.
- The cabin capacity (M³) must be within heater specification.
- The cabin door must always open outwards.

i. To reduce length or width of cabin.

Mark out on the panel (s) the portion to be cut off and cut through using a saw.. If metal fixing is hit, use a flexback hacksaw blade in a pad saw to cut fixing. If using a circular saw use a TCT blade and proceed slowly.

Remove framework (2 x 32) from discarded panel, strip off claddings etc. place 32 x 32 frame against remaining panel and mark off position of cross braces. Cut framework to marked lines and push back into panel to be flush and pin in place through outer claddings.

Safety Note

The panels are constructed using metal fastenings and contain fibreglass/rockwool insulation, safety goggles and dust mask must be worn if using power tools.

ii. Roof

Cut roof panel as if for side panel, if reducing length of panel use same sequence, measure, mark, cut, replace



framework and pin in place.

Important note.

Make sure the recut frame work is a good fit between cross braces. As the panel carries the load of the roof. If you are reducing both length and width of the cabin, ensure the modified ends of panels are never adjacent to each other.

iii. To reduce the height of cabin

First check heater clearances then proceed as for side and roof panels. If you are in any doubt regarding clearances please ring our Technical Department.

iv. Benches

Reduce side slats by same amount as wall panels, remove any part of the fillet blocks that impede the fixing of the notched cross rails and refix vertical blocks for end rail fixing – screw and glue ALL joints.

33. Locating accessories.

i. Thermometer

Inside cabin approx 200mm from ceiling on opposite wall from stove.

ii. Sand timer

Inside cabin – on any wall but away from stove.

iii. Wall light – inside cabin

Lamp & Shade – Centre wall above bench. Approx 100mm from ceiling.

iv. Low Voltage Lights (deluxe model)

Holes can be drilled where applicable (not factory pre-drilled)

v. Instruction card – outside cabin.

vi. Sauna Clock (deluxe model) – outside cabin

vii. Sauna Heater – inside cabin

See layout drawing of cabin

Please note sauna heaters do not operate from a 3 pin plug, they require hard wiring using high temperature silicon rubber cable to BSEN 6141. (not included) Electricians can normally obtain this from their supplier but in case of difficulty please contact our technical department for further advice. The length you will require depends upon the distance between where you locate your control box and the heater.

viii. Control Box for Heater – outside cabin

Please note sauna heaters do not operate from a 3 pin plug, they require hard wiring using high temperature silicon rubber cable to BSEN 6141. (not included) Electricians can normally obtain this from their supplier but in case of difficulty please contact our technical department for further advice. The length you will require depends upon the distance between where you locate your control box and the heater.

If you encounter any difficulty with this assembly procedure or think we could have explained anything more clearly we would welcome your comments; please call 01902 871127 technical help line.