

Oceanic

Sauna & Steam

Heavy Duty Commercial
STEAM GENERATOR



31.7.17

Table of contents

1.	Introduction	3
2.	Important Notes	3
3.	Safety Precautions	3
4.	Electrical connection	3
5.	Specification	4
5.1.	Steam Generator Unit Parameters	4
5.2.	Steam Generator Frame Sizes	6
5.3.	Clearance distances	6
5.4.	Ventilation	6
5.5.	Steam Generator Parts Description	7
5.6.	Table 2. OC-D Controller Parameters	8
5.7.	Temperature Sensor Parameters	8
6.	OC-A Controller Description	9
7.	Installation	10
7.1.	Generator Size	10
7.2.	Steam Generator Location	11
7.3.	Water and Steam Connections	12
7.4.	Installation for controller and temperature probe	13
7.5.	Installations for power supply and control cable	13
7.6.	Installing a light	13
8.	Steam on Demand Function (Only supplied with commercial generators)	14
9.	Circuit Diagrams	14
10.	Testing and operation	16
10.1.	Setting time and temperature	16
10.2.	Steam on Demand	16
11.	Troubleshooting guide	17
12.	Maintenance	18
12.1.	Descaling procedure	18
13.	Guarantee	19

1. Introduction

Thank you for choosing to buy our Oceanic steam generator, please take the time to read these instructions before you begin as they contain important information about the installation and maintenance requirements.

“Oceanic” heavy duty steam generators are available in specifications from 6kw to 12kw and are equipped with a programmable thermostatic controller. The controller is set with the time and day and allows you to program the generator to turn on and off automatically when you require, the generator can also be set to clean itself automatically. Once these settings have been saved the machine can be left to work on its own. The machine still must be checked on a regular basis for safety.

It is also possible to have the generator working off a push button which you place outside of the steam room, when customers push the button it illuminates and they get 30 minutes of steam.

The machine can also just work on a count down timer for say the next 90 minutes.

Our display tells you everything that the generator is doing, if it takes in water, heats, reached temperature, draining, descaling, light on, fan on, timer set.

You can also Lock the keys so other users can't play with the settings. Light of the steam room, the automatic drain valve, key-lock, alter the temperature display between Centigrade and Fahrenheit; as well as displaying the steam generator's status by the 8 LED's on the panel, heating, water inlet, temperature, drain status etc. Note also that one “OC-D” controller can control multiple “Oceanic” steam generators.

Every “Oceanic” steam generator is thoroughly tested before leaving the factory so there may be the remains of water inside the boiler.

2. Important Notes

- Read the manual before installation and operation.
- This Equipment must be installed by competent person.
- This equipment must be connected to an all pole isolator
- Disconnect the power supply before exposing electrical connections.
- Confirm the correct voltage to your steam generator 1 or 3 phase.
- For hard water areas please use a water softener.
- Water supply must have maximum of 1 bar pressure, we recommend the use of a pressure reducing valve if necessary

3. Safety Precautions

- Elderly persons, pregnant women, or those suffering heart disease, high blood pressure, diabetes or not in good health are advised to seek medical opinion before using a steam room.
- Do not smoke in the steam room.
- Avoid using the steam room immediately after strenuous exercise.
- Do not use the steam room when under the influence of alcohol.
- Leave the steam room at once if you feel sleepy, sick or uncomfortable.
- Ensure there is good ventilation for the steam room.
- We do not recommend that children under 16 use this product.
- Commercial operators should post a notice of these precautions in a prominent position.

Steam entering the steam room will be scalding hot; take care to position the inlet nozzle away from where users will sit and/or provide adequate guarding, post a notice to caution

4. Steam Generator Parts

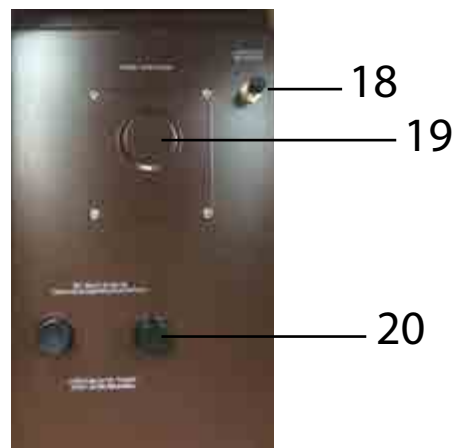
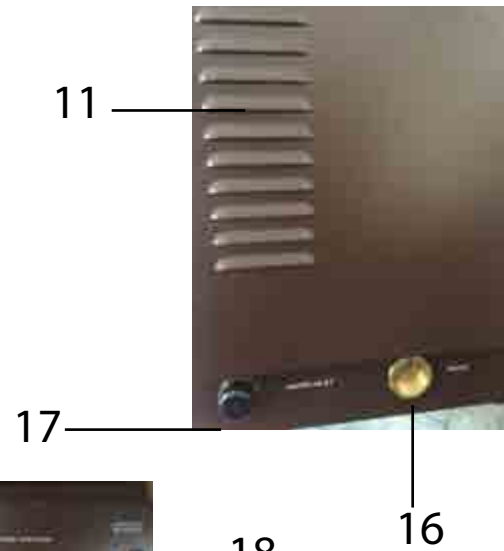
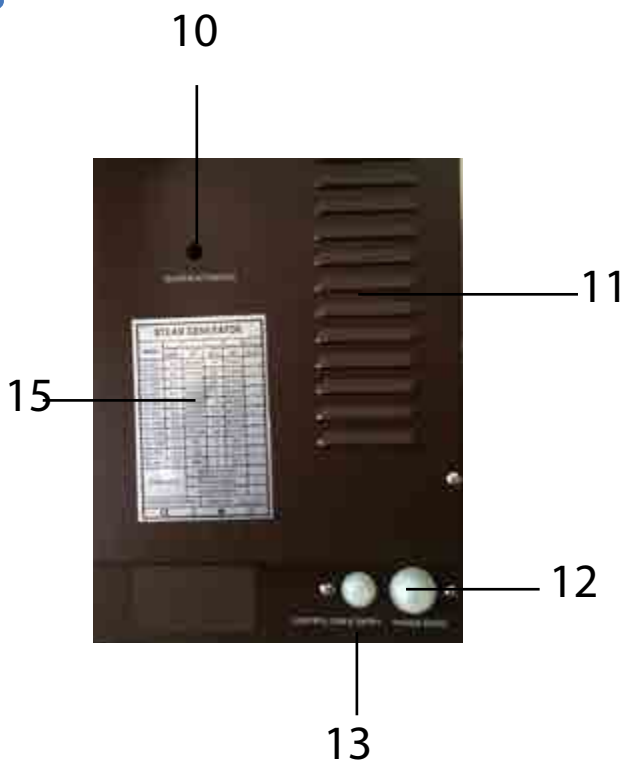
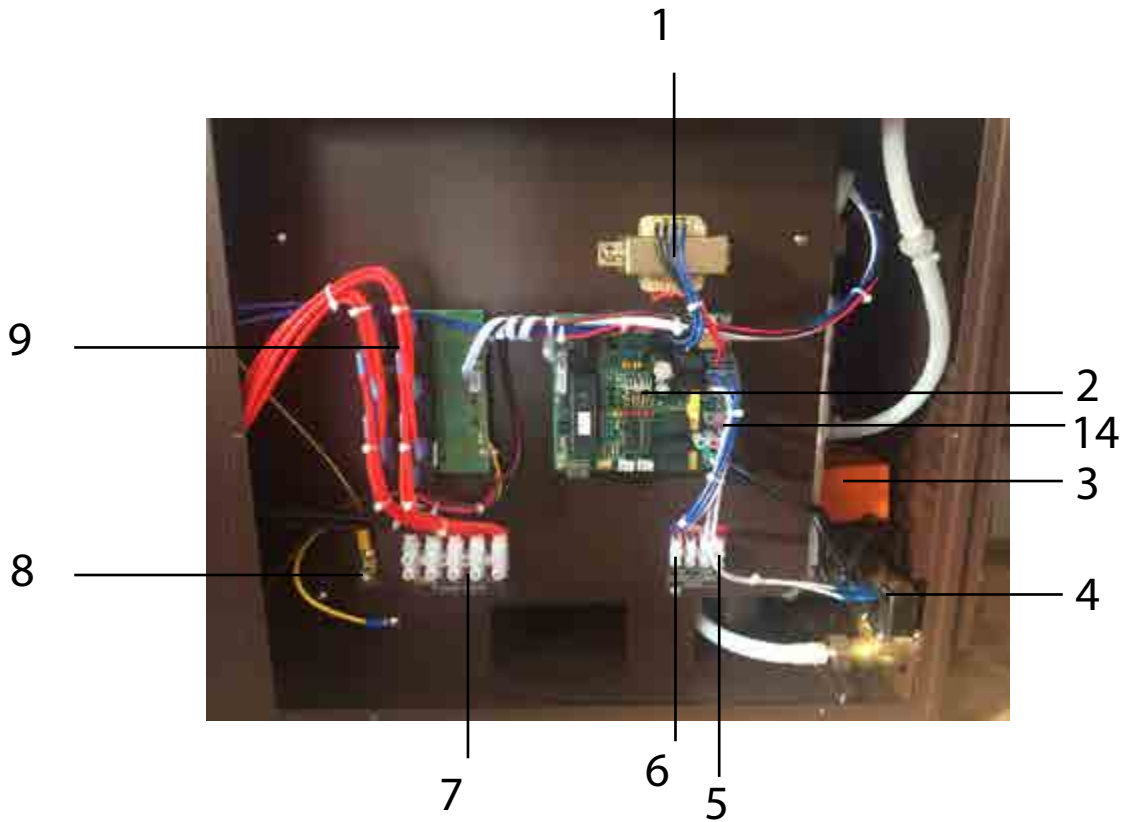

No.	Part	Description
1	Transformer	240v - 9v + 12v
2	Main Circuit Board	Control Centre
3	Drain Valve	3/4" Motorised Ball Valve
4	Inlet Valve	240v Brass Solenoid Valve
5	Light Connection	230v Light Output Switched by Keypad Max (100w)
6	Fan Connection	230v Fan Output Switched by Keypad Max (100w)
7	Power In Connection	Terminal for connection of 230 or 400v power.
8	Earth Connection	Earth Connection
9	Relay Circuit Board	Electrically operated switches for elements.
10	Overheat switch	Boil dry protector operates at 105oC Use Pin to reset
11	Louvers	Ventilation
12	Main Power Cable Entry	Cable entry and restraint for in coming power.
13	Control lead entry	Cable entry for control wire and descaling pump.
14	Descaling Pump Connection	Red & Blue Wires with Grey Connector (supplied separately in the box)
15	Information Chart	For info on Model, Voltage, Wattage and Ampage.
16	Drain connection	3/4" Female Brass
17	Water In Connection	1/2 Male Brass
18	Acid Inlet	Hose Nipple for Silicone Descaling Tube Secure with cable tie
19	Water Probe Access	Water Probe Access Plate
20	Steam Outlets	3/4" male steam outlets. Use brass fittings supplied

5. Electrical and plumbing connections

A qualified electrician will have no problem installing this system with the provided wiring schematic and with the help of the circuit diagram mounted inside the respective control unit. According to the valid regulations, the electrical connection of the steam generator and the control box has to be carried out by an authorised electrician. In case of a warranty claim, you are kindly requested to present a copy of the invoice from the electrician.

MODEL	POWER	CURRENT (amps)		SIZE (mm)			STEAM OUTLET	WATER INLET	DRAIN	NOZZLE TYPE
	Kw	1N~	3N~	L	W	H	inches	inches	inches	
Steam On Demand										
OCD-60	6	26	8.6	535	260	380	3/4 (2of)	1/2"	1/2"	Red
OCD-90	9	39	13	535	260	380	3/4 (2of)	1/2"	1/2"	Red
OCD-120	12	52	17.3	535	260	380	3/4 (2of)	1/2"	1/2"	Red



Temperature Sensor



5m DIN cable main circuit board to controller

OC-D Controller



Descaler Pump



3/4" Steam Inlet Nozzles

3/4" Steam outlet



Pressure relief valve



Steam On Demand button



Steam Generator Manual

5.1. Connections diagram and table

No.	Part	Description	Supplied
1	Water inlet	1/2" copper pipe (maximum pressure 1bar)	Not supplied
2	Pressure reducer valve	Set to 1bar maximum.	Not supplied
3	Washing machine trap	Both drain and steam overflow feed into	Not supplied
4	Drain	3/4" flexible hose	Not supplied
5	Pressure Release Pipe	1/2" copper pipe	Not supplied
6	Descaler inlet	Flexible silicon pipe secured with	Supplied
7	Descaling pump	Pumps descaling solution into generator	Supplied
8	Descaling solution container	Large plastic container filled with descaling solution	Optional 120L
9	Pressure relief valve	Operates if the pressure in the boiler exceeds 1.2kg/ c m2	Supplied
10	Brass T junction	3/4" to 3/4" and 1/2" brass fitting to fit steam pipe and pressure relief valve	Supplied
11	Brass T	3/4" T fitting for secondary steam outlet	Supplied
12	3/4" female cap	To block off secondary steam outlet	Not supplied
13	Steam pipe	Copper pipe from generator to steam inlet inside steam room (10m max length)	Not supplied
14	Steam inlet nozzle	3/4" nozzle fitted inside steam room	Supplied
15	Control cable	5m 6 core cable to control keypad	Supplied
16	Control keypad	To be mounted inside or outside steam room	Supplied
17	Lighting circuit	230V cable to lighting circuit connection on inside of generator (optional)	Not supplied
18	Mains input	Single or Three phase supply	Not supplied
19	Isolator Switch	Mains isolator	Not supplied
20	Power to descaler pump	230V power cable for descaler pump	Supplied

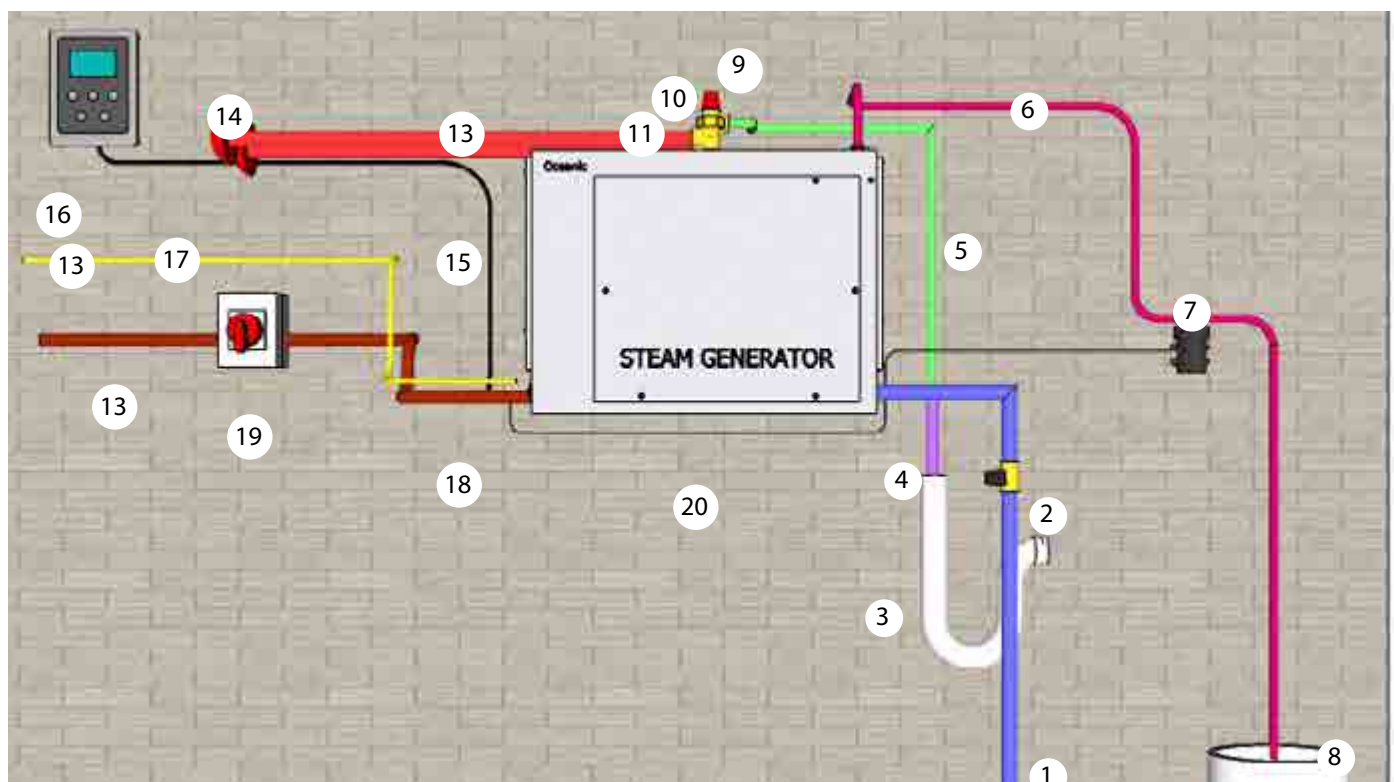

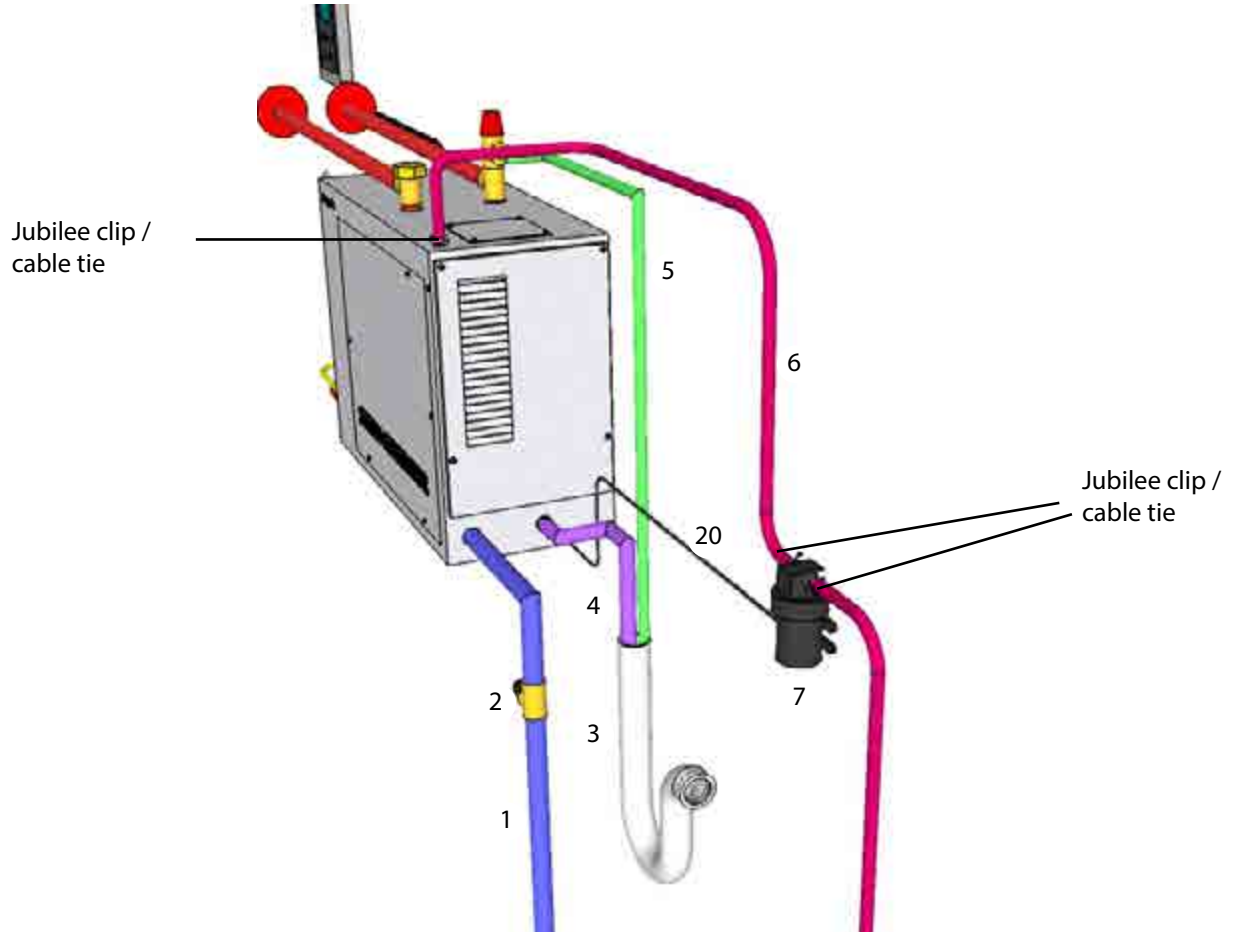
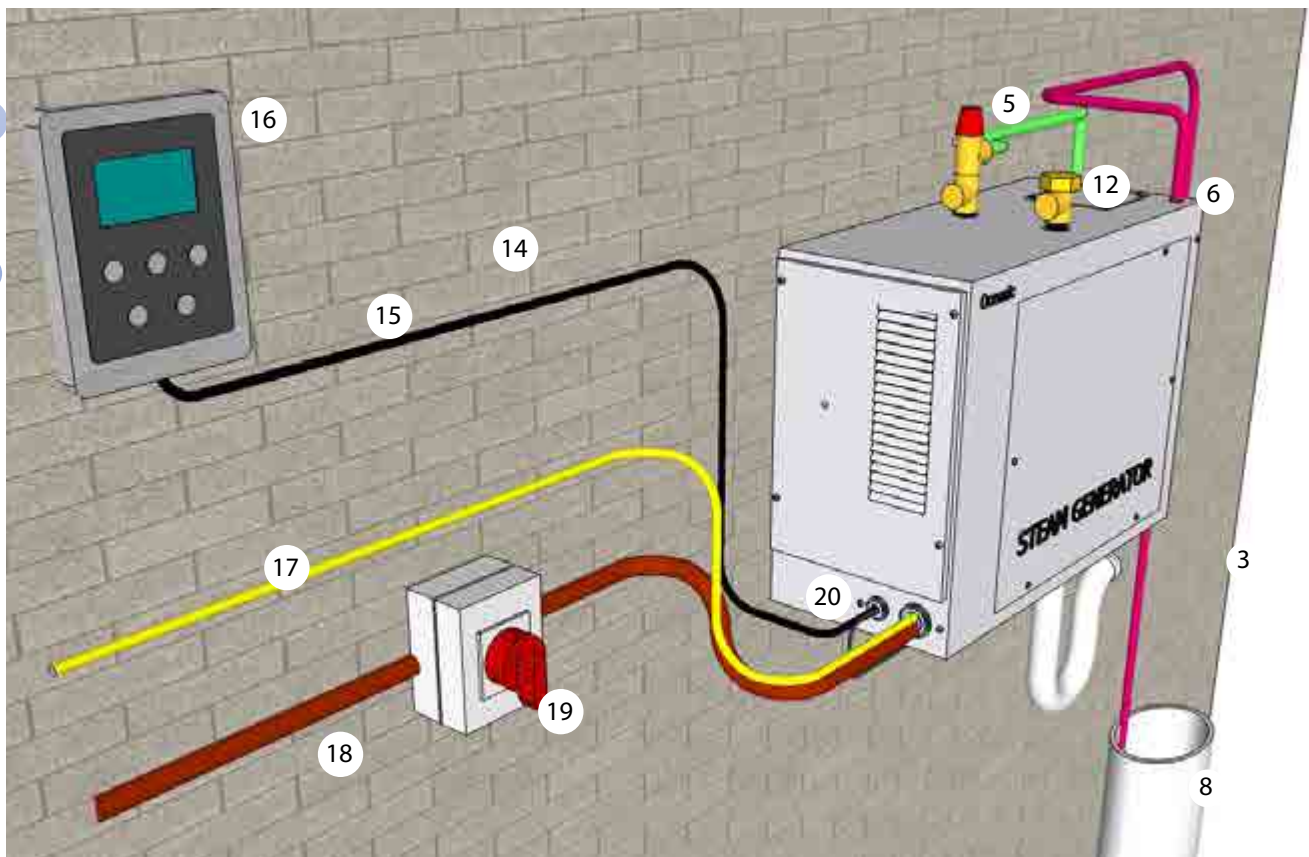

Steam Generator Manual

5.2. Steam Pipe Connection Options

Option A

Installation with two steam pipes.
Recommended for generators above 9kw

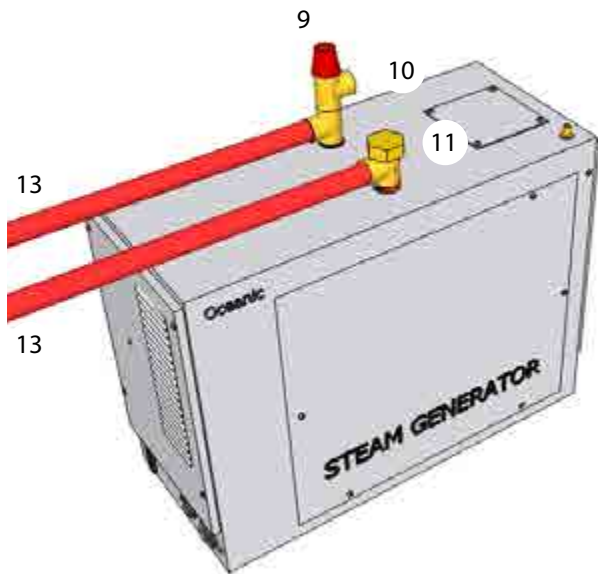

Option B

Installation with one steam pipe
Use a 3/4" female cap to block off the secondary outlet

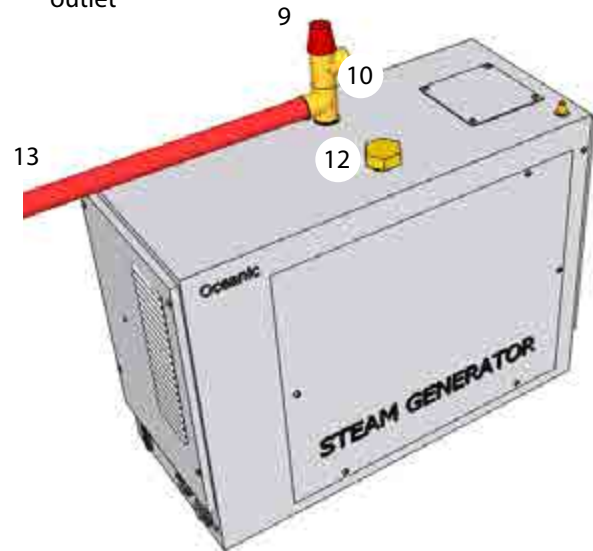

Important note: Steam outlet must not be reduced

5.3. Electrical connection schematic

Refer the the circuit diagram on the following page for further details.

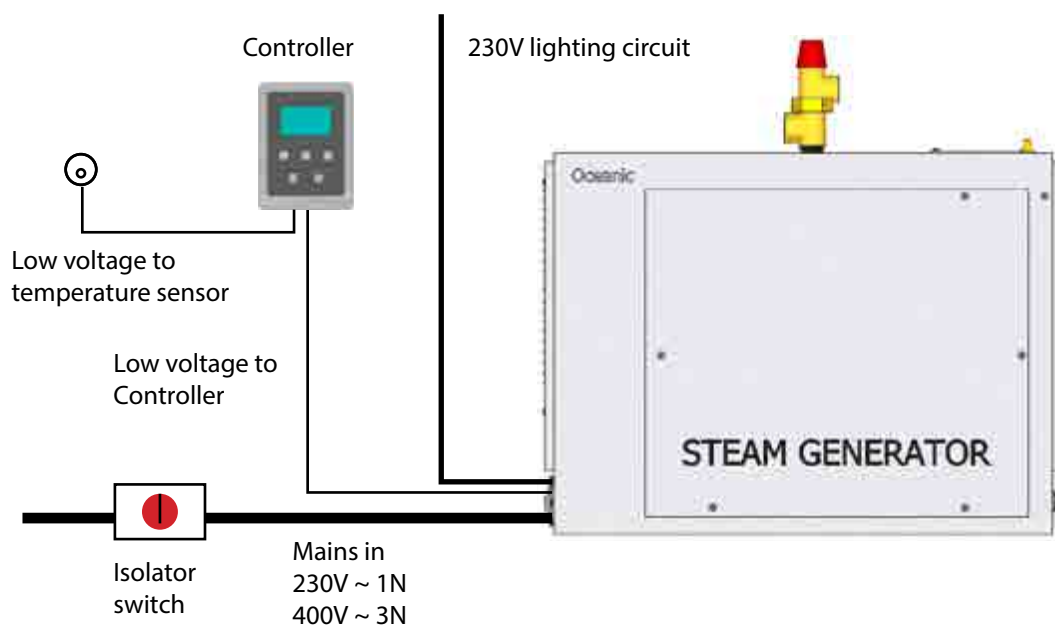

5.4. Circuit Diagram

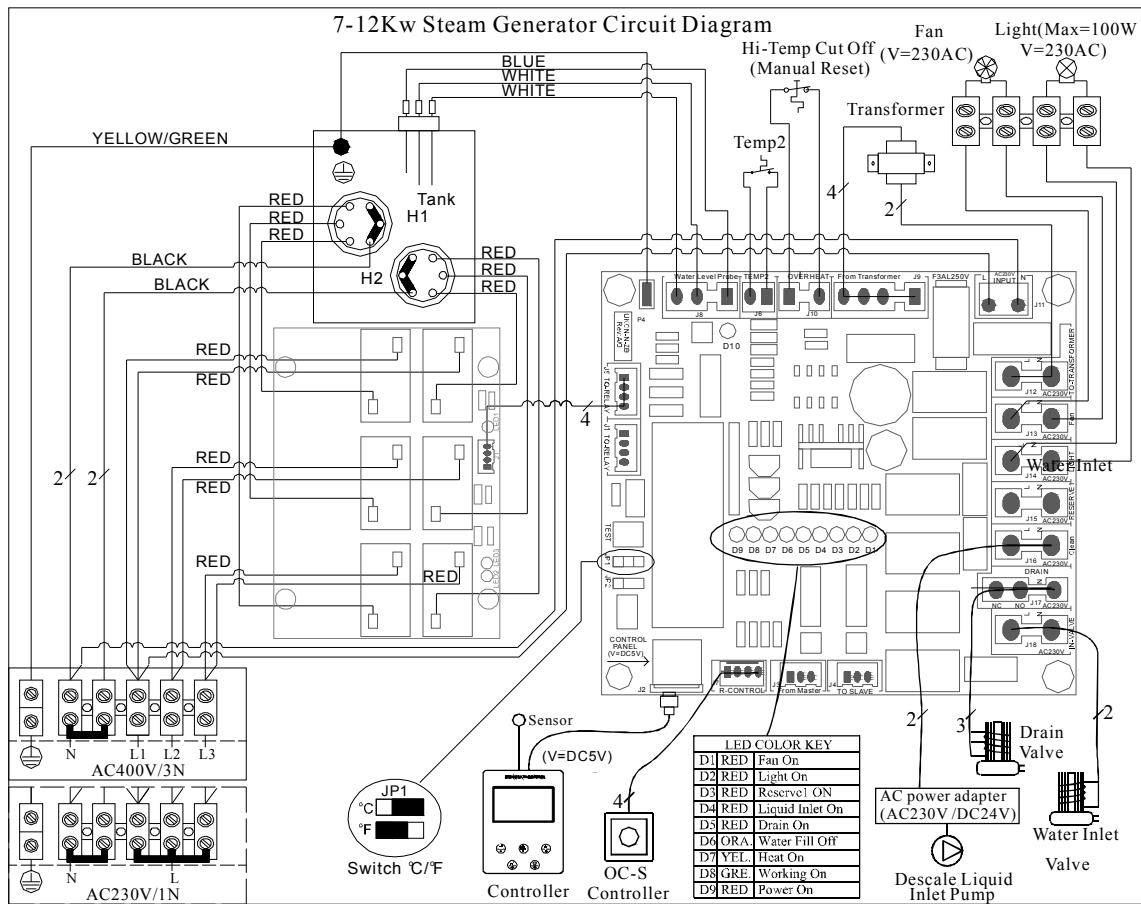

Note: To use the steam generator in single phase the L1 L2 and L3 must be linked together with the copper bridges that are supplied

5.5. Wiring Multiple Generators

If greater power is required one OC-D controller may be used to control two or more steam generators, e.g. if you need a 24KW steam generator you can use one OC-D controller to control two 12kw steam generator or three 10kw steam generators.

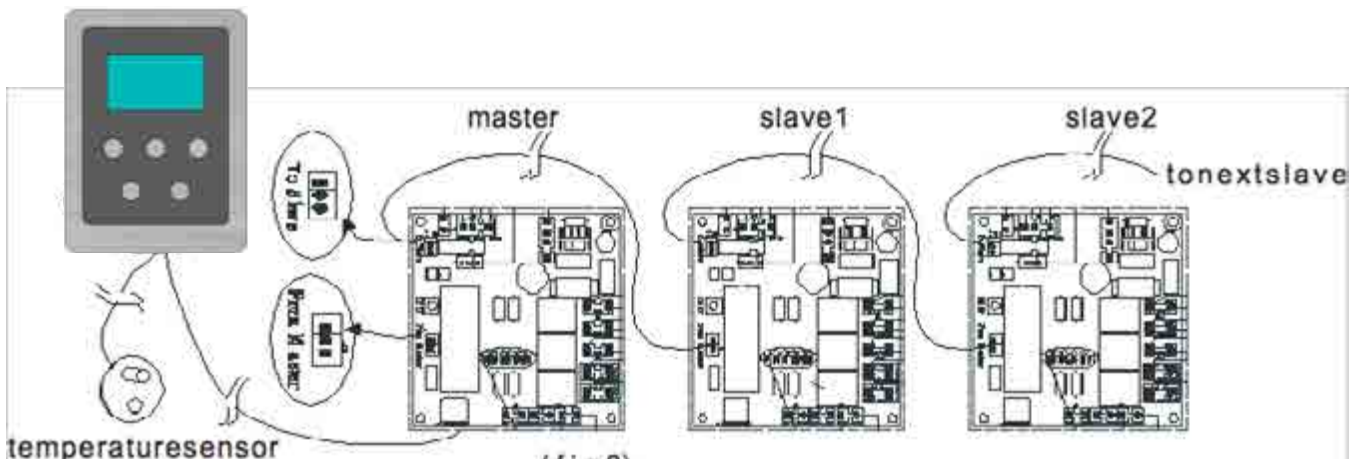

6. Parameters

6.1. Steam Generator Frame Sizes

Model	A	B	C	D	E	F
OCD - 60	535	260	380	25	135	45
OCD-90	535	260	380	35	135	45
OCD-120	535	260 <td 380	25	135	45	

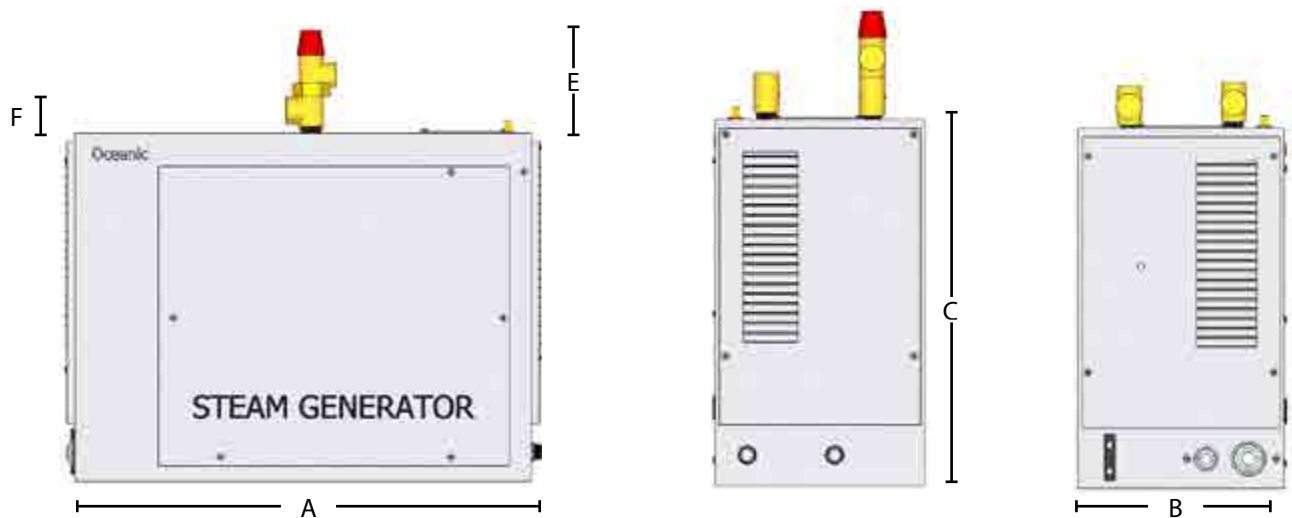

6.2. Clearance distances

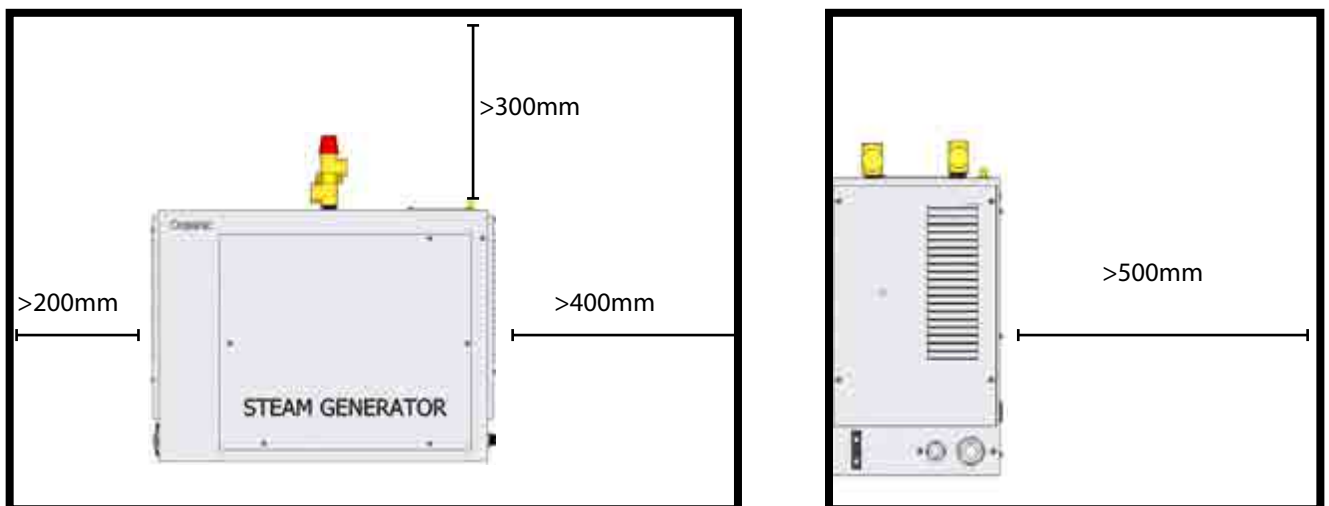

6.3. Ventilation

Ensure air flow into area where steam generator is housed.

For commercial use ensure good ventilation from at least two ducts within the housing of the generator

Steam Generator Manual

6.4. Table 2. OC-D Controller Parameters

Model	Temperature (°C)	Dimension (mm)
OC-D	30 - 60 °C	155 x 115 x 20



6.5. Temperature Sensor Parameters

MODEL	DETECTED SCOPE		MAX CUT OUT TEMPERATURE		SIZE (mm)		
	°C	°F	°C	°F	L	W	H
OC-S	0-110	32-230	60	248	76	42	27

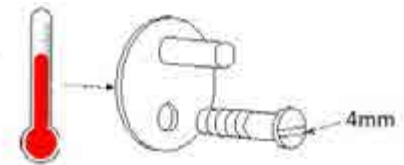
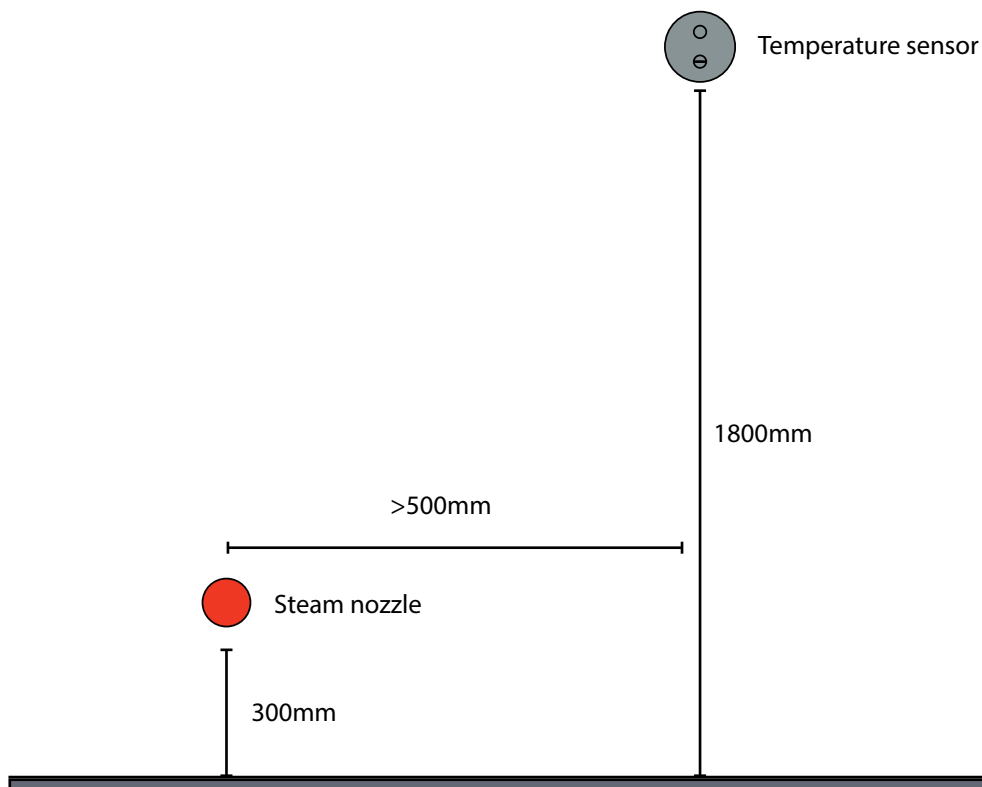

Diagram to show location of temperature sensor and steam inlet nozzle



7. Installation

- Isolate the power supply before installation
- Confirm the model you have selected is suitable for your steam room, please refer to chart below
- Mount the steam inlet nozzle approximately 300mm up from the floor and it should be at least 200mm from person's body.
- If the steam generator is installed in an inaccessible place ensure that both the electrical power and water supply can be isolated in an emergency.
- To use the steam generator in single phase the L1 L2 and L3 must be linked together with the copper bridges that are supplied. See circuit diagram on page 9.
- The minimum water inlet pressure is 0.25 bar (2.5 Mpascals) and the maximum is 2 bar (20 Mpascals), for pressures in excess of this use a reducer before the valve as shown in diagrams on page 6 and 7.
- The steam pipe from steam generator to steam room should be kept to a minimum, pipes longer than 3 meters should be insulated to prevent heat loss. Steam pipes will be hot during use and must be protected against accidental contact. Steam entering the steam room will be scalding hot; take care to position the inlet nozzle away from where users will sit and/or provide adequate guarding, post a notice to caution users.
- Keep the number of right angle bends to a minimum and ensure that the run does not create a trap into which condensate would gather and cause a blockage I.e. the pipe must not go down and then up.
- There must be no valve or other blockage in the steam pipe
- The steam pipe should be metal or other material that can endure 150°C temperature, copper pipe is recommended.
- It is not recommended to install the steam generator outdoors or where it might be affected by frost. Allow for a minimum space of 0.5 cubic meters to install the generator.
- Steam generator should be level side-to-side and front to back and should be installed so that the arrows on the case point up.
- Do not install the steam generator in close proximity to hazardous substances.

7.1. Generator Size

The table opposite should be referred to for guidance only. Please note that the size of generator required to heat a particular size of steam room will vary according to a number of factors including the type of material used for construction, the height of the steam room and the ambient temperature.

Generator Model	Steam Room Volume (m ³)
OC-60	4.5 - 6
OC-90	6 - 10
OC-120	8 - 12
OC-150	11 - 15

For lightweight materials such as plastics and laminates 1 KW will heat up to 1 cubic meter of air for dense materials such as stones and ceramics which will conduct the heat away more rapidly allow for up to 2KW per cubic meter of air. Hot air rises so restricting the height to around 2 meters will ensure the user is sitting in the steam for higher ceilings you may need to increase the power requirement.

Steam Generator Manual

7.2. Steam Generator Location

The steam generator should be installed in dry well ventilated place in close proximity to the steam room. It can be placed on the floor or hung on wall.

To hang the generator on a wall drill 3 holes 8mm in diameter in accordance with the table below. Fix the top 2 screws in place first then hang the generator by the 2 keyhole shaped holes in the back plate. Then with the front cover removed fix the 3rd screw to secure the unit in place.

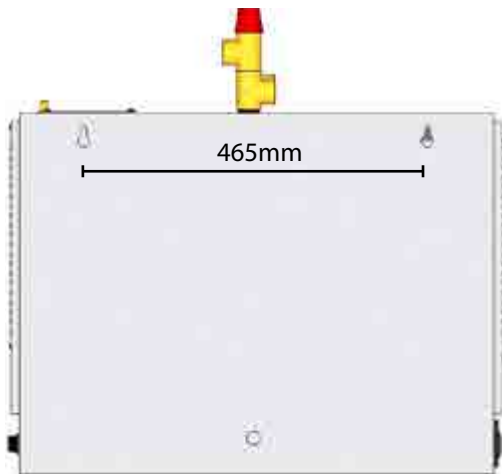

The steam generator can be installed anywhere that is dry and has an airflow.

Example locations:

- Plant Room
- Cupboard in an adjacent room
- In the loft
- Up to 1.5m beneath the unit in a basement

Important notes:

- The steam pipe should be insulated and not travel further than 10 metres
- Do not reduce size of steam pipe at any point
- the steam pipe must not go down and then up, as this will create a trap and damage the steam generator.

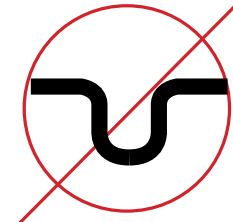
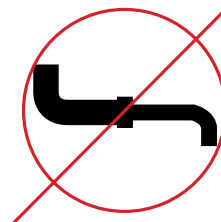
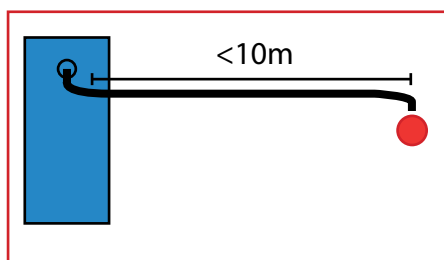

7.3. Water and Steam Connections

- i. The water supply pipe and steam pipe should comply with local standards
- ii. Connect the water inlet valve of the generator to the mains water supply using a flexible hose with 1/2 inch fittings.
- iii. Steam outlet (1/2 inch or 3/4 inch) use the same dimension copper pipe to connect it, if the steam pipe is longer than 5 meter it should be insulated. During use the steam pipe will be very hot and must be protected against accidental contact. Note that according to the location it may be necessary to attach an additional length of pipe to the pressure relief valve in order to divert the steam flow to a safe direction should the valve operate.
- iv. Connect the drain outlet to a suitable drain via a copper pipe with the appropriate fittings.

7.4. Installation for controller and temperature probe.

OC-A controller is waterproof and can be installed inside or outside the steam room according to customer preference.

- i. For a better connection and to eliminate any future connection problems spray connection fluid or aerosol oil spray on the pins of the PS/2 cable(5pin cable) before plugging into the circuit board.
- ii. Ideally the control panel should be installed at a height of approximately 1200mm for ease of use.
- iii. Installation method: Open the front cover of steam generator. Pin the control cable (6 cores) and temperature sensor cable (2 cores) to the relevant ports.
- iv. Control panel installation: pin one end to circuit board ports in steam generator connect the other end to the controller's cable.
- v. Temperature probe installation: the temperature probe is installed inside the steam room at approximately 1.2 to 1.5 meters high and away from the steam outlet. Use a 4mm screw fix it in place and then connect to the wire from the controller.
- vi. Fix protective cover (supplied) over the temperature

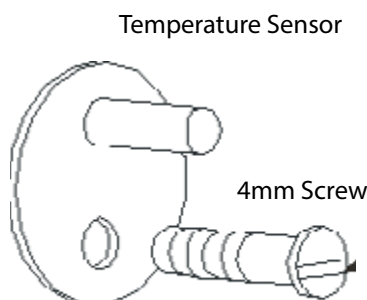

Cover to protect the temperature sensor

7.5. Installations for power supply and control cable

Confirm the correct voltage of power supply and wires.

Remove the knock out for the power cable entry and use a rubber grommet to protect the cable, connect to the conductors to the correct terminals – for single phase power supply use the copper bridge connectors, for 3 phase supply remove them. (Extra bridges can be found if provided)

Remove the knock out for the control cable entry and use a rubber grommet to protect the cable, connect the cable to the relevant port on circuit board.

Ensure the power supply wire and control cable remain separated to prevent magnetic field of power supply wire from disturbing control cable signal.

7.6. Installing a light

There is a 230v power supply inside the steam generator labelled “Light”. This is rated to 100w Max. The button on the keypad will turn this power supply off and on. This power supply is protected by a fuse on the main circuit board but you can add your own fused spur for extra protection if you prefer.

7.7. Installing a Fan

Same as above for a light.

7.8. Connecting to descaler

- i. The descaling pump is powered off a 24v transformer which is supplied, there is a grey connector with a blue and red wire coming from supplied separately, this grey connector plugs into a 230v connection on the circuit board labelled “clean”. Bring the 230v cable out from the generator and mount the transformer on the wall in a electrical box suitable for wet areas.
- ii. OCD Generator is able to run automatically descale cycle by pumping descaling solution directly into the tank. This can be set to occur at regular intervals using the controller as described on page 20.
- iii. The pump supplied should be connected via silicon hose to the generator and the container of descaling solution.
- iv. The diagram on pages 6 and 7 show how the descaling solution should be connected via the pump. Ensure the the ends of the hose are held in place with cable ties.
- v. Both descaling crystals and 120 litre container can be purchased from www.Oceanic-Saunas.co.uk



8. Steam on Demand Function

Commercial operators may wish to take advantage of the steam on demand function which will allow customers to press the steam on demand button located inside or outside the steam room

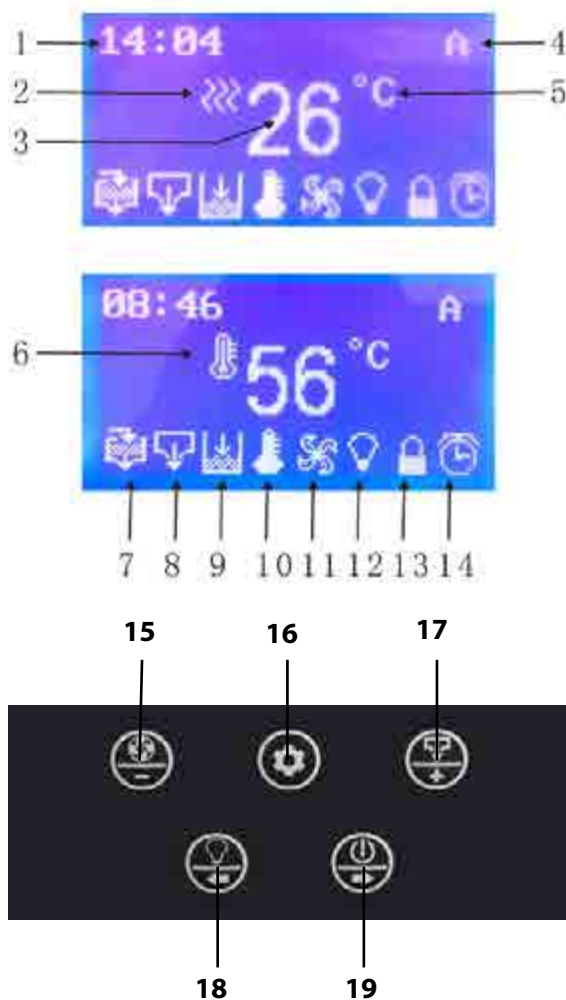

1	Time 24hr
2	Heat Symbol
3	Current Temperature In Room
4	Work Mode e.g Normal, SOD, Auto
5	Centigrade or Farienheit
6	Set Temperature Has Been Reached
7	Descale Cycle On
8	Draining
9	Water Needed, Filling - Valve Open If flashing - No Water Supply
10	Generator Has Overheated
11	Fan On
12	Light On
13	Keypad Locked
14	Auto Timer Set
15	Fan On / Decrease (-)
16	Setting
17	Drain (Must Be Off) / Increase (+)
18	Light On / Left Scroll
19	Machine On/Off / Right Scroll

after which the generator will create steam for 30 minutes then return to an idle state until activated again. This function reduces running costs and frequency of maintenance.
See instructions on page 19 for how to set up the function on the OCD Controller.

Programmable Controller User Instructions

8.1. Display and Buttons

8.2. Turning On/Off

When power has been switched on to the machine the keypad will sound a short beep to indicate that it has been powered up.

To turn on push



You should now see the default display which should look like this.



Steam Generator Manual

8.3. Time and Day

Push  push  until you reach



Push for ok



You can now use the increase and decrease, left and right buttons to set the hours, minutes and day.

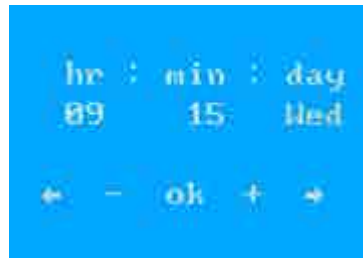

8.4. Setting Temperature

- i. You can set the temperature between 35 and 60°C and between 95 and 140°F.
- ii. If you are a novice user we advise to start at around 38°C and when you are comfortable with this temperature start to increase slowly by 1°C between each bathing session.

Push  to enter setting



Push  to enter temperature settings



Increase  or  Decrease

Push  to save

Steam Generator Manual

8.5. Working Modes

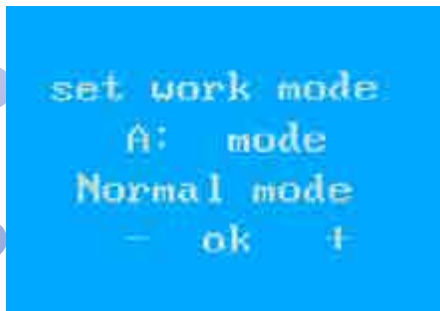

- i. Mode A - This is a count down timer. You can set for upto 4 hours or for continuous heating.

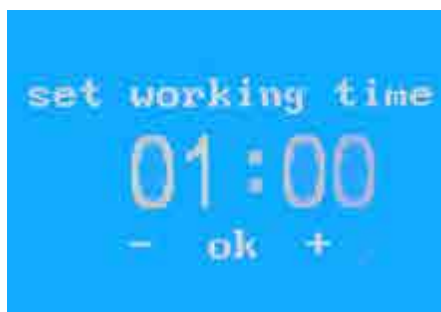
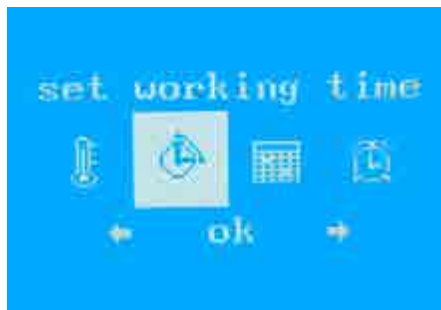

- ii. Change the time using the up and down keys.
Press  to save the setting
- iii. Once set the home screen should look like this.

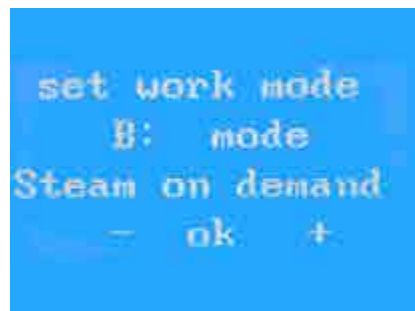

- iv. Mode B - Steam On Demand. (Commercial only) Install a button outside of the steam room, when a customer pushes the button they get 30 minutes of steam. With steam on demand you only need to set the temperature of the room. When the red button is push it will illuminate to let users know the generator is working. Once set the home screen should look like this.



- vi. You can choose in the morning from between 0.00 - 11:59 noon. And in the afternoon from 12:00 - 23:59.
- vii. To activate morning(1) or afternoon(2) change the X to a Tick, now set the time you want the machine to turn on and off. As you can see above we have set from 6 to 12 in the morning and from 12 noon to 23:55 at night.

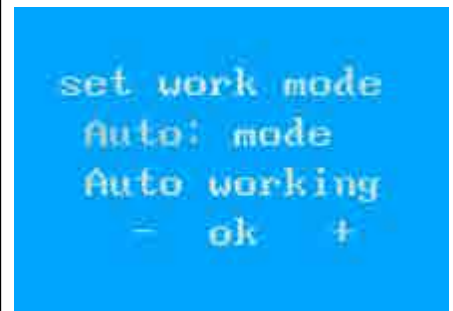

- v. Mode Auto - Program specific times for the generator to turn on and off throughout the day. Once setup machine will remember to turn on or off at these same times everyday.

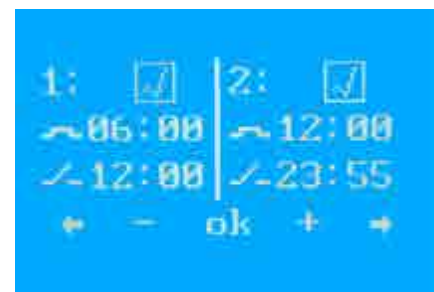

- viii. Once setup the home screen should look like this.
- ix. If you isolate power to the machine it will forget your settings and go back to default.



8.6. Auto Descale

- i. Set the machine to automatically descale itself once per week. Once set the machine will descale itself at the same time every week.
- ii. The descaling solution will still need to be topped up, our 120 litre drums will do about 10 descales before refilling with acid. Mix 5kgs of acid for the whole 120 litres of acid or around 40-50gs of acid per litre.
- iii. For some operators it may not be necessary for you to be descaling the generator every week as you may not be in a hard water area or you may only be operating the machine for a few hours per day. In this case we advise not to have the machine set up for a regular descale and to only turn the descaling cycle on when you need it. You must remember though that once the cycle has been completed you must turn the Tick to a X to turn the weekly descale off.

To setup descaling push



Push
to enter

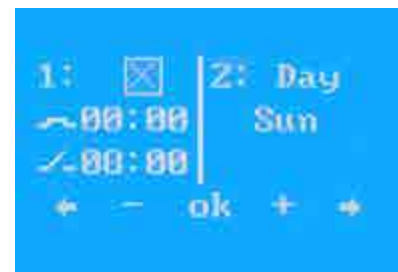

- iv. The default is Sunday between midnight 00:00 and 8:00 in the morning.
- v. To activate descale change the X to a Tick.
- vi. You can also adjust the day and time that the descale will operate. We advise a minimum of 4 hours.
- vii. Note the screen must be turned off for the descale cycle to run.

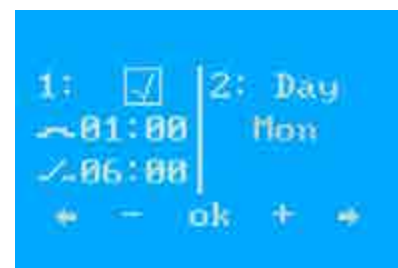

8.7. Drain

- i. You won't ever really need to drain the machine as it automatically drains itself. While steaming the generator will drain out the water so that there is never a concentrated solution of limescale in the tank. It will also completely drain and flush itself after it has been turned off. (not isolated)
- ii. To drain the machine you first need the screen to be off, so if it is already on push the On/off button to turn it off. Now push the Drain button, screen will illuminate and indicate the drain symbol as shown below on the right.

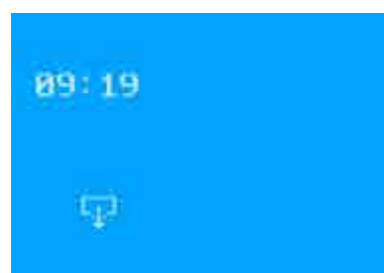

Steam Generator Manual

8.8. Light and Fan

- i. The light and fan will stay on if the keypad is off, so that if you use the room as a shower the light can still remain on.
- ii. To turn the fan or light on or off just push the button with the light or fan symbol.
- iii. The Light has maximum load of 100watts, the Fan has a maximum load of 100watts.

8.9. Screen Lock

- i. To lock the screen push the '+' button for 5 seconds.
- ii. When the controller is locked the 'light' button and 'on/off' button will still be functional.

9. Troubleshooting guide

Please note that we recommend all repairs are carried out by a suitably qualified person.

Trouble description	Cause Something is wrong with:	Solution
No Steam	Settings not correct Connection Power supply Transformer. Main circuit board controller Control cable or port Connection Fuse	Has the control been set up correctly, follow user guide page 19. Is water light on - check water supply - check valve coil for continuity. Remove and clean water level probe with emery cloth Descale machine Check fuse Check power output from transformer Replace Main PCB
Water coming out of steam nozzle.	Water Level Probe	Remove and clean water level probe Check connections to and from water level probe
Circuit breaker tripping out.	Element failure Loose Earth Wire Faulty connection	1. To check elements use a insulation tester, or fault find by disconnecting individual elements one by one. 2. Check earth connections are tight. 3. If above fails, return generator to supplier for repair, guarantee information below.
Temperature window displays "LC"	The temp sensor connection	1. Check connection or change temp sensor. 2. If above fails replace sensor.
Temperature window display "HC"	Temp sensor is short circuit.	1. Check connection or change temp sensor. 2. If above fails replace sensor.
Water runs through steam nozzle in room.	Water inlet valve. Level sensor.	1. Turn machine off, if water continues clean inlet valve or replace. 2. If runs while machine is on try above if fails clean water probe and check connection to circuit board.
Generator works when switched off on the control panel.	Relays	1. Replace relay PCB.
Filling symbol is flashing		Check water supply

10. Maintenance

The single biggest problem with steam generation is the build up of scale resulting from dissolved solids within the water. Scaling can cause the elements to fail, the water level sensors not to function, premature failure of the O-rings resulting in leaks from around the elements. The extent of the problem will vary according to the degree of hardness in the local water supply. For all commercial operators we recommend the use of a water softener.

Expect 2500 hours element life, this can be seriously depleted by poor maintenance.

All users commercial and domestic must ensure a regular maintenance routine to descale the generator – the frequency of this will vary according to the degree of hardness in the local water supply and the amount of time the generator is used for. Check the water for hardness and arrange the descaling routine accordingly: -

High levels of hardness descale once every 50 to 100 hours of operation.

Medium levels of hardness descale once every 100 to 250 hours operation.

Low levels of hardness descale once every 250 to 1000 hours of operation.

To descale the generator use a solution of weak acid crystals (such as citric acid) mixed with water

Citric acid can be purchased from:

www.thebathingplace.com

www.oceanic-saunas.eu

11. Guarantee

All generators are guaranteed for 12 months for domestic and commercial use from the date of purchase. This guarantee excludes consumable items such as the electrical elements and failures resulting from misuse or abuse such as a not descaling the machine.

If you are using the generator for more than 20 hours a week in a hard water area without a water softener your guarantee will be invalidated.

If you encounter any difficulty with this assembly procedure or think we could have explained anything more clearly we would welcome your comments, please call T: 01902 655425 or T: 01902 871127 technical help line.